

SAMSUNG

Mobile Device
SM-T835/T830
Common

SERVICE ***Manual***

Mobile Device

CONTENTS

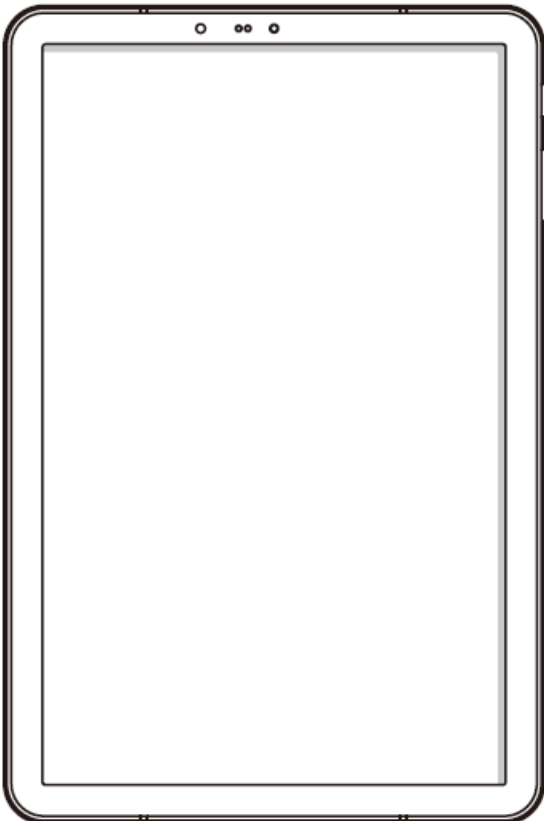

1. Safety Precautions
2. Specification
3. Product Function
4. Exploded View and Parts list
5. MAIN Electrical Parts List
6. Level 1 Repair
7. Level 2 Repair
8. Level 3 Repair
9. Reference Abbreviation

Notice: All functionality, features, specifications, and other product information provided in this document, including but not limited to, benefits, design, pricing, components, performance, availability, and capabilities of the product are subject to change without notice. Samsung reserves the right to alter this document or the product described herein at anytime, without obligation to provide notification of such changes.

1. Safety Precautions

1-1. Repair Precaution

Before attempting any repair or detailed tuning, shield the device from RF noise or static electricity discharges.

Use only demagnetized tools that are specifically designed for small electronic repairs, as most electronic parts are sensitive to electromagnetic forces.

Use only high quality screwdrivers when servicing products. Low quality screwdrivers can easily damage the heads of screws.

Use only conductor wire of the properly gauge and insulation for low resistance, because of the low margin of error of most testing equipment.

We recommend 22-gauge twisted copper wire.

Hand-soldering is not recommended, because printed circuit boards (PCBs) can be easily damaged, even with relatively low heat. Never use a soldering iron with a power rating of more than 100 watts and use only lead-free solder with a melting point below 250°C (482°F).

Prior to disassembling the battery charger for repair, ensure that the AC power is disconnected.

Always use the replacement parts that are registered in the SEC system. Third-party replacement parts may not function properly.

1. Safety Precautions

1-2. ESD(Electrostatically Sensitive Devices) Precaution

Many semiconductors and ESDs in electronic devices are particularly sensitive to static discharge and can be easily damaged by it. We recommend protecting these components with conductive anti-static bags when you store or transport them.

Always use an anti-static strap or wristband and remove electrostatic buildup or dissipate static electricity from your body before repairing ESDs.

Ensure that soldering irons have AC adapter with ground wires and that the ground wires are properly connected.

Use only desoldering tools with plastic tips to prevent static discharge.

Properly shield the work environment from accidental electrostatic discharge before opening packages containing ESDs.

The potential for static electricity discharge may be increased in low humidity environments, such as air-conditioned rooms. Increase the airflow to the working area to decrease the chance of accidental static electricity discharges.

2. Specification

[SM-T835]

2-1. GSM & WCDMA General Specification

Item	GSM850	EGSM 900	DCS1800	PCS1900	WCDMA 2100	WCDMA 1900	WCDMA 850
Freq. Band[MHz] Uplink/ Downlink	824.2~848.8 869.2~893.8	876.2~914.8 921.2~959.8	1710.2~1784.8 1805.2~1879.8	1850.2~1909.8 1930.2~1989.8	1922.4~1977.6 2112.4~2167.6	1852.4~1907.6 1932.4~1987.6	826.4~846.6 871.4~891.6
ARFCN range	128~251	0~124 & 975~1023	512~885	512~810	UL: 9612~9888 DL: 10562~10838	UL: 9262~9538 DL: 9662~9938	UL: 4132~4233 DL: 4357~4458
Tx/Rx spacing	45MHz	45MHz	95MHz	80MHz	190MHz	80MHz	45MHz
Mod. Bit rate/ Bit Period	270.833kbps 3.692us	270.833kbps 3.692us	270.833kbps 3.692us	270.833kbps 3.692us	3.84Mcps	3.84Mcps	3.84Mcps
Time Slot Period/ Frame Period	576.9us 4.615ms	576.9us 4.615ms	576.9us 4.615ms	576.9us 4.615ms	FrameLength: 10ms Slotlength: 0.667ms	FrameLength: 10ms Slotlength: 0.667ms	FrameLength: 10ms Slotlength: 0.667ms
Modulation	0.3GMSK	0.3GMSK	0.3GMSK	0.3GMSK	QPSK/16QAM	QPSK/16QAM	QPSK/16QAM
MS Power	33dBm~5dBm	32.5dBm~5dBm	29.5dBm~0dBm	29.5dBm~0dBm	24dBm~-50dBm	24dBm~-50dBm	24dBm~-50dBm
Power Class	5pcl ~ 19pcl	5pcl ~ 19pcl	0pcl ~ 15pcl	0pcl ~ 15pcl	3(max+24dBm)	3(max+24dBm)	3(max+24dBm)
Sensitivity	-102dBm	-102dBm	-102dBm	-102dBm	-106.7dBm	-104.7dBm	-104.7dBm
TDMA Mux	8	8	8	8	8	8	8
Cell Radius	35Km	35Km	2Km	2Km	2Km	2Km	2Km

2. Specification

Item	WCDMA 1700	WCDMA 900
Freq. Band[MHz] Uplink/ Downlink	1712.4~1752.6 2112.4~2152.6	882.4~912.6 927.4~957.6
ARFCN range	UL: 9612~9888 DL: 10562~10838	UL: 9262~9538 DL: 9662~9938
Tx/Rx spacing	400MHz	45MHz
Mod. Bit rate/ Bit Period	3.84Mcps	3.84Mcps
Time Slot Period/ Frame Period	FrameLength: 10ms Slotlength: 0.667ms	FrameLength: 10ms Slotlength: 0.667ms
Modulation	QPSK/16QAM	QPSK/16QAM
MS Power	24dBm~ -50dBm	24dBm~ -50dBm
Power Class	3(max+24dBm)	3(max+24dBm)
Sensitivity	-106.7dBm	-103.7dBm
TDMA Mux	-	-
Cell Radius	2Km	2Km

2. Specification

2-2. LTE General Specification

Item	LTE Band1	LTE Band2	LTE Band3	LTE Band4	LTE Band5
Freq. Band[MHz] Uplink/ Downlink	1920~1980 2110~2170	1850~1910 1930~1990	1710~1785 1805~1880	1710~1755 2110~2155	824~849 869~894
ARFCN range	UL: 18000~18599 DL: 0~599	UL: 18600~19199 DL: 600~1199	UL: 19200~19949 DL: 1200~1949	UL: 19950~20399 DL: 1950~2399	UL: 20400~20649 DL: 2400~2649
Tx/Rx spacing	190MHz	80MHz	95MHz	400MHz	45MHz
Channel Bandwidth	5/10/15/20 MHz	1.4/3/5/10/15/20 MHz	1.4/3/5/10/15/20 MHz	1.4/3/5/10/15/20 MHz	1.4/3/5/10 MHz
Modulation	QPSK,16/64QAM	QPSK,16/64QAM	QPSK,16/64QAM	QPSK,16/64QAM	QPSK,16/64QAM
MS Power (MPR)	-35~25.7 dBm	-35~25.7 dBm	-35~25.7 dBm	-35~25.7 dBm	-35~25.7 dBm
Sensitivit (QPSK) (BW 10MHz)	-96.3 dBm	-94.3 dBm	-93.3 dBm	-96.3 dBm	-94.3 dBm
Cell Radius	>5Km	>5Km	>5Km	>5Km	>5Km

2. Specification

Item	LTE Band7	LTE Band8	LTE Band20	LTE Band17	LTE Band40	LTE Band66
Freq. Band[MHz] Uplink/ Downlink	2500~2570 2620~2690	880~915 925~960	832~862 791~821	704~716 734~746	2300~2400	1710~1780 2110~2200
ARFCN range	UL: 20750~21449 DL: 2750~3449	UL: 2712~2863 DL: 2937~3088	UL: 24150~24449 DL: 6150~6449	UL: 23730~23849 DL: 5730~5849	38650~39649	UL: 131972~13267 1 DL: 66436~67335
Tx/Rx spacing	120MHz	45MHz	-41MHz	30MHz	-	400MHz
Channel Bandwidth	5/10/15/20 MHz	1.4/3/5/10 MHz	5/10/15/20 MHz	5/10 MHz	5/10/15/20 MHz	1.4/3/5/10/15/20 MHz
Modulation	QPSK,16/64QAM	QPSK,16/64QAM	QPSK,16/64QAM	QPSK,16/64QAM	QPSK,16/64QAM	QPSK,16/64QAM
MS Power (MPR)	-35~25.7 dBm	-35~25.7 dBm	-35~25.7 dBm	-35~25.7 dBm	-35~25.7 dBm	-35~25.7 dBm
Sensitivit (QPSK) (BW 10MHz)	-94.3 dBm	-93.3 dBm	-93.3dBm	-93.3 dBm	-96.3 dBm	-95.8 dBm
Cell Radius	>5Km	>5Km	>5Km	>5Km	>5Km	>5Km

2. Specification

[SM-T830]

Not applicable

3. Product Function

Main Function

Item	Description
OS	Android 8.1
SM-T835 RF	2G : 850/900/1800/1900 3G : B1,2,4,5,8 LTE : Band B1/2/3/5/4/7/8/12/13/17/20/28/38/40/41/66
Battery	7,300mAh
Base Band	MSM 8998 Octa-Core 2.35GHz, 1.9GHz
Other RF	USB 3.1, BT5.0, GPS, Glonass,Beidou,Galileo, WIFI 802.11 a/b/g/n/ac 2.4GHz+5GHz
Camera	13.0MP AF, 8.0MP FF
LCD	10.5" 2560X1600(WQXGA), Super AMOLED
RAM	4G LPDDR4X+64G UFS
Sensor	Accelerometer, IRIS ,Gyro,Geomagnetic,Light,RGB Light,Hall Sensor
Accessory	Charger: 9V/1.67A Data cable: 2.8pi, 1.2m

4. Exploded View and Parts List

4-1-1. Cellular phone Exploded View [SM-T835]

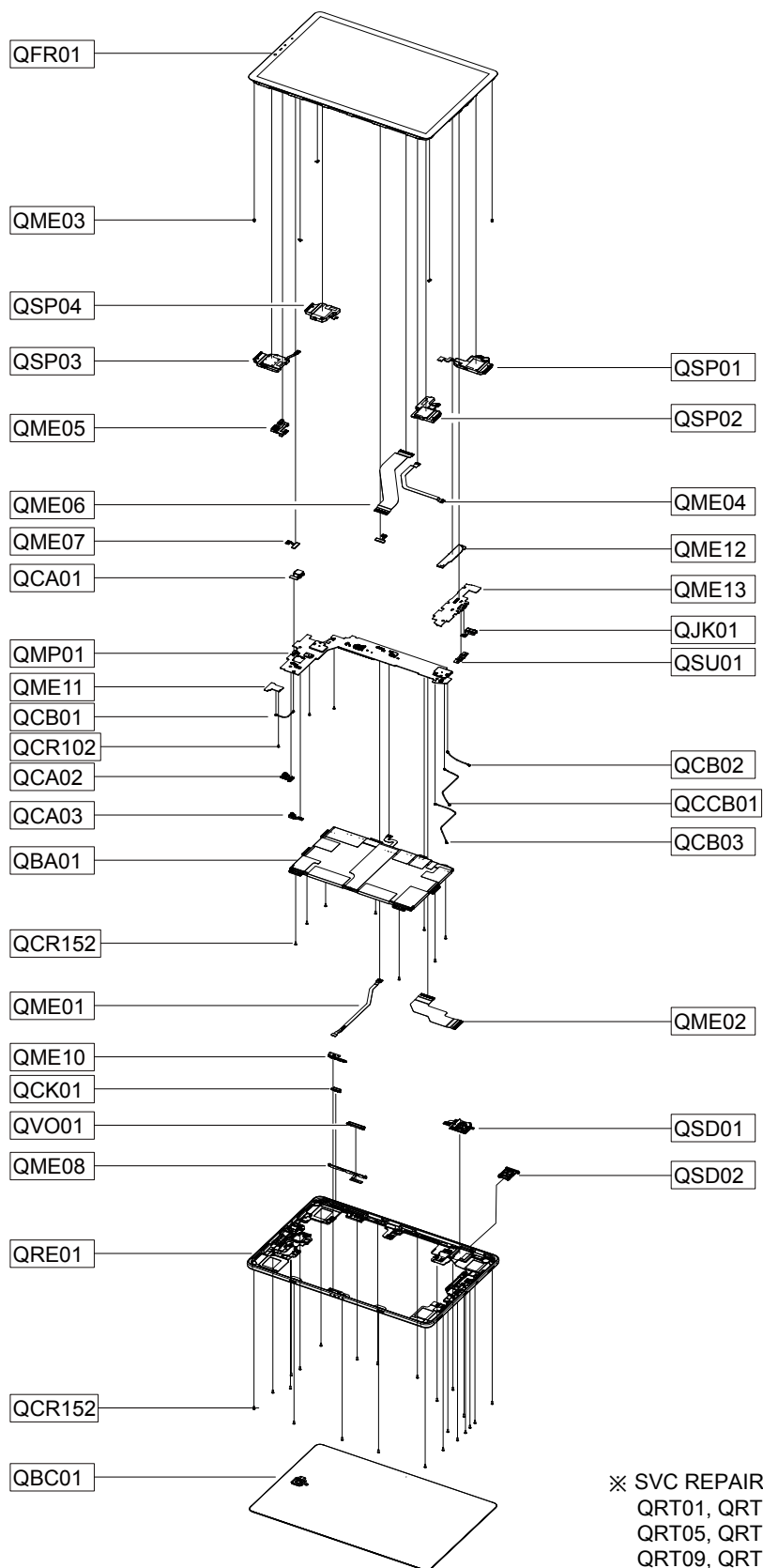

4. Exploded View and Parts List

4-1-2. Cellular phone Exploded View [SM-T830]

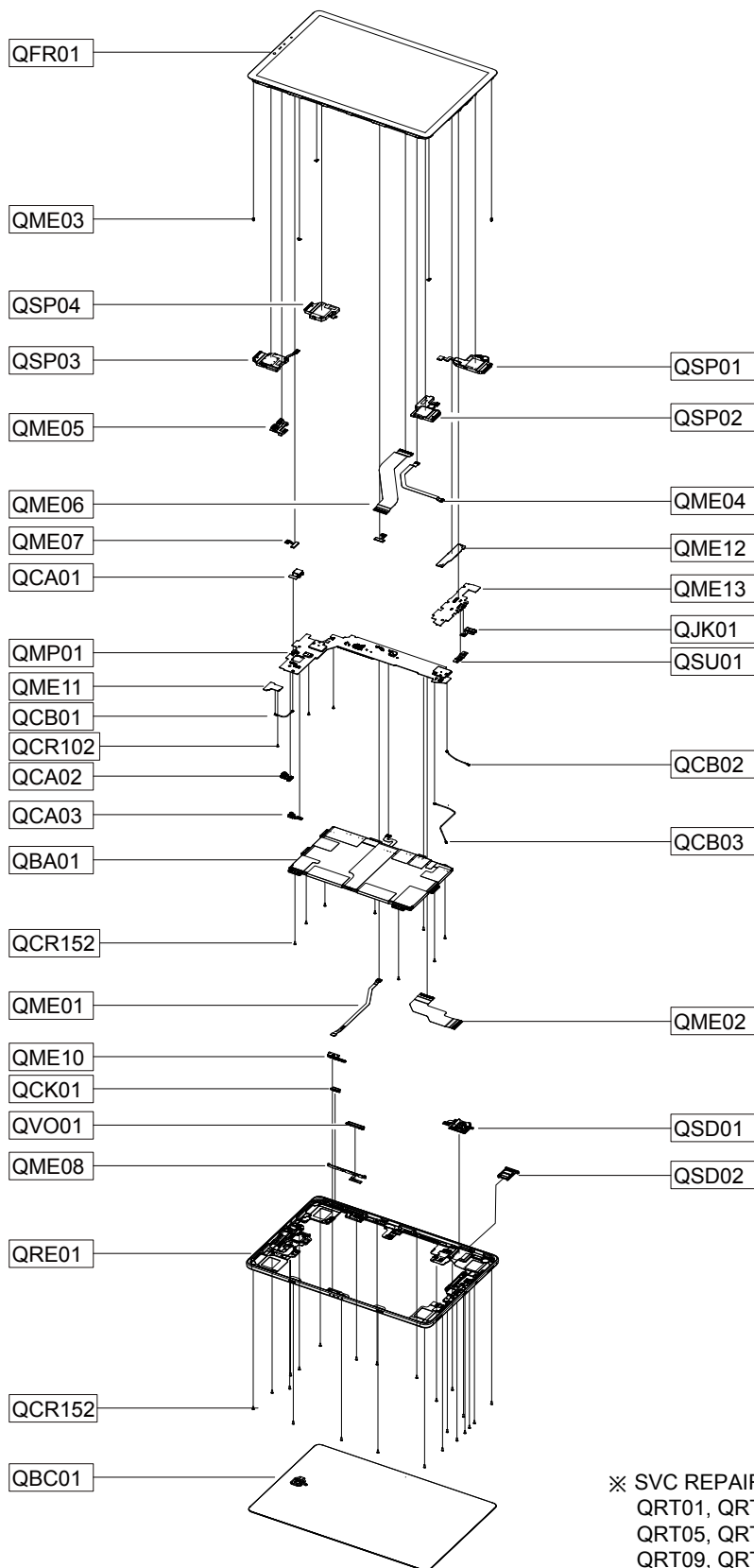

5. MAIN Electrical Parts List

[SM-T835]

Parts Code	Design Loc	Part Name
0202-002125	C1214	SOLDER-SHORT
0202-002125	R10008	SOLDER-SHORT
0202-002125	R1005	SOLDER-SHORT
0202-002125	R10060	SOLDER-SHORT
0202-002125	R6035	SOLDER-SHORT
0202-002125	R6045	SOLDER-SHORT
0202-002125	R6046	SOLDER-SHORT
0202-002125	TP_UB4001	SOLDER-SHORT
0202-002125	U2013	SOLDER-SHORT
0202-002125	U2015	SOLDER-SHORT
0202-002126	R3048	SOLDER-SHORT
0202-002126	R3053	SOLDER-SHORT
0404-001250	D5000	DIODE-SCHOTTKY
0404-001250	D5006	DIODE-SCHOTTKY
0406-001506	D2000	DIODE-TVS
0406-001506	D2001	DIODE-TVS
0406-001506	D5003	DIODE-TVS
0406-001506	D7001	DIODE-TVS
0406-001506	ZD1001	DIODE-TVS
0406-001506	ZD1002	DIODE-TVS
0406-001561	D10008	DIODE-TVS
0406-001709	D10006	DIODE-TVS
0406-001709	D10007	DIODE-TVS
0406-001728	ZD5000	DIODE-TVS
0406-001743	D7000	DIODE-TVS
0406-001743	D7003	DIODE-TVS
0406-001743	D7004	DIODE-TVS
0406-001743	D7005	DIODE-TVS
0406-001743	D7006	DIODE-TVS
0406-001743	D7007	DIODE-TVS
0406-001763	D7002	DIODE-TVS
0406-001763	D7008	DIODE-TVS
0406-001763	D7009	DIODE-TVS
0406-001763	D7010	DIODE-TVS
0406-001763	ZD1000	DIODE-TVS
0406-001780	D10000	DIODE-TVS
0406-001780	D10001	DIODE-TVS
0406-001780	D10002	DIODE-TVS

Confidential and proprietary-the contents in this service guide subject to change without prior notice

Distribution, transmission, or infringement of any content or data from this document without Samsung's written authorization is strictly prohibited.

5. MAIN Electrical Parts List

0406-001780	D10003	DIODE-TVS
0406-001781	D10004	DIODE-TVS
0406-001781	D10005	DIODE-TVS
0406-001781	ZD10013	DIODE-TVS
0406-001781	ZD10014	DIODE-TVS
0406-001791	C1067	DIODE-TVS
0406-001797	D10015	DIODE-TVS
0406-001797	D10016	DIODE-TVS
0406-001797	D5005	DIODE-TVS
0406-001797	ZD10017	DIODE-TVS
0406-001797	ZD7007	DIODE-TVS
0406-001797	ZD7008	DIODE-TVS
0406-001804	ZD10001	DIODE-TVS
0406-001804	ZD10003	DIODE-TVS
0406-001804	ZD10004	DIODE-TVS
0406-001804	ZD10005	DIODE-TVS
0406-001804	ZD10006	DIODE-TVS
0406-001804	ZD10007	DIODE-TVS
0406-001804	ZD10008	DIODE-TVS
0406-001804	ZD10009	DIODE-TVS
0406-001804	ZD10010	DIODE-TVS
0406-001804	ZD10011	DIODE-TVS
0406-001808	D5004	DIODE-TVS
0406-001808	D7011	DIODE-TVS
0505-001883	TR5005	FET-SILICON
0505-002088	TR8000	FET-SILICON
0505-003234	TR5000	FET-SILICON
0505-003234	TR5002	FET-SILICON
0505-003234	TR5004	FET-SILICON
0505-003618	TR5003	FET-SILICON
0601-003702	LED8000	LED
0801-003435	U8002	IC-CMOS LOGIC
1001-001755	U10018	IC-ANALOG SWITCH
1001-001994	U1015	IC-RF SWITCH
1001-002046	U10033	IC-RF SWITCH
1001-002055	U1010	IC-RF SWITCH
1003-002951	U5032	IC-POWER DRIVER
1003-002965	U10025	IC-LEVEL DRIVER
1009-001070	U10003	IC-HALL EFFECT S/W
1009-001070	U7008	IC-HALL EFFECT S/W

Confidential and proprietary-the contents in this service guide subject to change without prior notice

Distribution, transmission, or infringement of any content or data from this document without Samsung's written authorization is strictly prohibited.

5. MAIN Electrical Parts List

1105-002900	UCP300UP	IC-DDR4 SDRAM
1107-002589	UME4000	IC-UNIVERSAL FLASH STORAGE
1201-003786	U2008	IC-GPS AMP
1201-004099	U10006	IC-AUDIO AMP
1201-004099	U6040	IC-AUDIO AMP
1201-004099	U6041	IC-AUDIO AMP
1201-004099	U6042	IC-AUDIO AMP
1201-004115	U1008	IC-POWER AMP
1201-004179	U1004	IC-POWER AMP
1203-007884	U8003	IC-DC/DC CONVERTER
1203-007884	U8004	IC-DC/DC CONVERTER
1203-008190	U7012	IC-POSI.FIXED REG.
1203-008217	U8015	IC-DC/DC CONVERTER
1203-008251	U5005	IC-POSI.FIXED REG.
1203-008251	U5017	IC-POSI.FIXED REG.
1203-008251	U8024	IC-POSI.FIXED REG.
1203-008322	U8005	IC-POSI.FIXED REG.
1203-008322	U8007	IC-POSI.FIXED REG.
1203-008468	U5012	IC-VOL. DETECTOR
1203-008468	U5013	IC-VOL. DETECTOR
1203-008475	U5001	IC-VOL. DETECTOR
1203-008698	U5002	IC-BATTERY
1203-008811	U5011	IC-DC/DC CONVERTER
1203-008850	U6008	IC-DC/DC CONVERTER
1203-008857	U10017	IC-POSI.FIXED REG.
1203-008865	U8001	IC-POSI.FIXED REG.
1203-008865	U8009	IC-POSI.FIXED REG.
1203-008867	U6002	IC-POSI.FIXED REG.
1203-008867	U6057	IC-POSI.FIXED REG.
1203-008867	U7003	IC-POSI.FIXED REG.
1203-008867	U7019	IC-POSI.FIXED REG.
1203-008898	U1017	IC-MODULATOR
1203-008903	U8023	IC-DC/DC CONVERTER
1203-008904	U5009	IC-POWER SUPERVISOR
1203-008930	U5010	IC-POWER SUPERVISOR
1203-008931	U5000	IC-POWER SUPERVISOR
1203-008940	U5024	IC-DC/DC CONVERTER
1203-008948	U6000	IC-POSI.FIXED REG.
1203-008955	U8008	IC-POSI.FIXED REG.
1203-009054	U5021	IC-VOL. DETECTOR

Confidential and proprietary-the contents in this service guide subject to change without prior notice

Distribution, transmission, or infringement of any content or data from this document without Samsung's written authorization is strictly prohibited.

5. MAIN Electrical Parts List

1204-003765	U6005	IC-AUDIO PROCESSOR
1205-005651	U9005	IC-TOUCH
1205-005737	U1006	IC-TRANSCIEVER
1205-005745	U6009	IC-CODEC
1205-005746	UCP300	IC-MODEM
1205-005821	U2010	IC-WIFI
1209-002450	U7009	IC-ACCEL./GYRO SENSOR
1209-002501	U1005	IC-TOUCH SENSOR
1209-002513	U7010	IC-MAGNETIC SENSOR
1301-002183	U5028	IC-FPGA
1404-001664	TH10000	THERMISTOR-NTC
1404-001724	TH1000	THERMISTOR-NTC
1404-001724	TH2000	THERMISTOR-NTC
1404-001724	TH3000	THERMISTOR-NTC
1404-001724	TH5000	THERMISTOR-NTC
1404-001724	TH5001	THERMISTOR-NTC
1404-001724	TH5010	THERMISTOR-NTC
1405-001395	V10002	VARISTOR
1405-001395	V10003	VARISTOR
1405-001404	VR8000	VARISTOR
1405-001412	VR1000	VARISTOR
1405-001412	VR1001	VARISTOR
1405-001431	VR1004	VARISTOR
1405-001433	VR10000	VARISTOR
1405-001433	VR10003	VARISTOR
1405-001433	VR1002	VARISTOR
1405-001433	VR1003	VARISTOR
1405-001433	VR1005	VARISTOR
1405-001433	VR9000	VARISTOR
1405-001433	VR9001	VARISTOR
2007-003015	R10021	R-CHIP
2007-003015	R10022	R-CHIP
2007-007014	R2017	R-CHIP
2007-007100	R1012	R-CHIP
2007-007107	R5001	R-CHIP
2007-007107	R5027	R-CHIP
2007-007107	R5028	R-CHIP
2007-007107	R5037	R-CHIP
2007-007107	R5047	R-CHIP
2007-007107	R5058	R-CHIP

Confidential and proprietary-the contents in this service guide subject to change without prior notice

Distribution, transmission, or infringement of any content or data from this document without Samsung's written authorization is strictly prohibited.

5. MAIN Electrical Parts List

2007-007107	R5081	R-CHIP
2007-007107	R6014	R-CHIP
2007-007107	R6016	R-CHIP
2007-007107	R8004	R-CHIP
2007-007107	R8011	R-CHIP
2007-007107	R8012	R-CHIP
2007-007107	R8013	R-CHIP
2007-007107	R9003	R-CHIP
2007-007107	R9007	R-CHIP
2007-007142	R10004	R-CHIP
2007-007142	R10005	R-CHIP
2007-007142	R5000	R-CHIP
2007-007142	R5025	R-CHIP
2007-007142	R5026	R-CHIP
2007-007142	R5030	R-CHIP
2007-007142	R5032	R-CHIP
2007-007142	R5033	R-CHIP
2007-007142	R5041	R-CHIP
2007-007142	R6037	R-CHIP
2007-007142	R7005	R-CHIP
2007-007142	R8008	R-CHIP
2007-007142	R8014	R-CHIP
2007-007142	R8036	R-CHIP
2007-007193	R10012	R-CHIP
2007-007193	R10015	R-CHIP
2007-007308	R8035	R-CHIP
2007-007309	R8031	R-CHIP
2007-007318	R1011	R-CHIP
2007-007318	R4000	R-CHIP
2007-007318	R5010	R-CHIP
2007-007517	R5042	R-CHIP
2007-007517	R5043	R-CHIP
2007-007573	R7011	R-CHIP
2007-007741	R5035	R-CHIP
2007-007741	R5045	R-CHIP
2007-007741	R6036	R-CHIP
2007-007741	R7024	R-CHIP
2007-007741	R8009	R-CHIP
2007-007798	R5007	R-CHIP
2007-007942	R5014	R-CHIP

Confidential and proprietary-the contents in this service guide subject to change without prior notice

Distribution, transmission, or infringement of any content or data from this document without Samsung's written authorization is strictly prohibited.

5. MAIN Electrical Parts List

2007-007946	R5015	R-CHIP
2007-008043	R2005	R-CHIP
2007-008043	R2012	R-CHIP
2007-008057	R1002	R-CHIP
2007-008057	R1003	R-CHIP
2007-008210	R2004	R-CHIP
2007-008210	R2011	R-CHIP
2007-008263	R3037	R-CHIP
2007-008263	R3038	R-CHIP
2007-008298	R2014	R-CHIP
2007-008420	R2019	R-CHIP
2007-008420	R2043	R-CHIP
2007-008420	R8002	R-CHIP
2007-008531	R10009	R-CHIP
2007-008531	R5016	R-CHIP
2007-008531	R8000	R-CHIP
2007-008531	R8001	R-CHIP
2007-008587	R6007	R-CHIP
2007-008686	R2001	R-CHIP
2007-008686	R2008	R-CHIP
2007-008766	R3055	R-CHIP
2007-008766	R3056	R-CHIP
2007-008774	R10027	R-CHIP
2007-008774	R10028	R-CHIP
2007-008774	R10029	R-CHIP
2007-008774	R10030	R-CHIP
2007-008774	R10031	R-CHIP
2007-008774	R10032	R-CHIP
2007-008774	R10041	R-CHIP
2007-008774	R10042	R-CHIP
2007-008774	R7014	R-CHIP
2007-008774	R7015	R-CHIP
2007-008774	R7016	R-CHIP
2007-008774	R7017	R-CHIP
2007-008774	R7018	R-CHIP
2007-008774	R7019	R-CHIP
2007-008774	R7020	R-CHIP
2007-008774	R7022	R-CHIP
2007-008798	R7012	R-CHIP
2007-008808	R5006	R-CHIP

Confidential and proprietary-the contents in this service guide subject to change without prior notice

Distribution, transmission, or infringement of any content or data from this document without Samsung's written authorization is strictly prohibited.

5. MAIN Electrical Parts List

2007-009111	R2000	R-CHIP
2007-009111	R2007	R-CHIP
2007-009111	R7027	R-CHIP
2007-009154	R3026	R-CHIP
2007-009155	R5040	R-CHIP
2007-009157	R3039	R-CHIP
2007-009157	R3042	R-CHIP
2007-009157	R5034	R-CHIP
2007-009157	R5036	R-CHIP
2007-009157	R5039	R-CHIP
2007-009158	R5009	R-CHIP
2007-009199	R1001	R-CHIP
2007-009201	R6009	R-CHIP
2007-009201	R6010	R-CHIP
2007-009201	R6011	R-CHIP
2007-009201	R6012	R-CHIP
2007-009201	R6020	R-CHIP
2007-009201	R6021	R-CHIP
2007-009212	R3047	R-CHIP
2007-009212	R5008	R-CHIP
2007-009212	R5018	R-CHIP
2007-009212	R6002	R-CHIP
2007-009212	R9005	R-CHIP
2007-009223	R6001	R-CHIP
2007-009352	R5046	R-CHIP
2007-009354	R7002	R-CHIP
2007-009354	R7003	R-CHIP
2007-009354	R7004	R-CHIP
2007-009408	R10010	R-CHIP
2007-009408	R10013	R-CHIP
2007-009408	R10014	R-CHIP
2007-009408	R1010	R-CHIP
2007-009408	R3000	R-CHIP
2007-009408	R3001	R-CHIP
2007-009408	R3002	R-CHIP
2007-009408	R3003	R-CHIP
2007-009408	R3004	R-CHIP
2007-009408	R3005	R-CHIP
2007-009408	R3006	R-CHIP
2007-009408	R3007	R-CHIP

Confidential and proprietary-the contents in this service guide subject to change without prior notice

Distribution, transmission, or infringement of any content or data from this document without Samsung's written authorization is strictly prohibited.

5. MAIN Electrical Parts List

2007-009408	R3010	R-CHIP
2007-009408	R3011	R-CHIP
2007-009408	R3014	R-CHIP
2007-009408	R3015	R-CHIP
2007-009408	R3016	R-CHIP
2007-009408	R3017	R-CHIP
2007-009408	R3018	R-CHIP
2007-009408	R3019	R-CHIP
2007-009408	R3020	R-CHIP
2007-009408	R3021	R-CHIP
2007-009408	R3023	R-CHIP
2007-009408	R3025	R-CHIP
2007-009408	R3027	R-CHIP
2007-009408	R3028	R-CHIP
2007-009408	R3029	R-CHIP
2007-009408	R3030	R-CHIP
2007-009408	R3031	R-CHIP
2007-009408	R3032	R-CHIP
2007-009408	R3033	R-CHIP
2007-009408	R3034	R-CHIP
2007-009408	R3057	R-CHIP
2007-009408	R3058	R-CHIP
2007-009408	R5017	R-CHIP
2007-009408	R5021	R-CHIP
2007-009408	R7023	R-CHIP
2007-009410	R1016	R-CHIP
2007-009410	R1021	R-CHIP
2007-009410	R2044	R-CHIP
2007-009410	R2045	R-CHIP
2007-009793	R6004	R-CHIP
2007-009801	R3035	R-CHIP
2007-009801	R3036	R-CHIP
2007-009801	R8007	R-CHIP
2007-009805	R1004	R-CHIP
2007-009805	R1006	R-CHIP
2007-009805	R1007	R-CHIP
2007-009805	R1008	R-CHIP
2007-009805	R1013	R-CHIP
2007-009805	R1014	R-CHIP
2007-009805	R1017	R-CHIP

Confidential and proprietary-the contents in this service guide subject to change without prior notice

Distribution, transmission, or infringement of any content or data from this document without Samsung's written authorization is strictly prohibited.

5. MAIN Electrical Parts List

2007-009805	R1018	R-CHIP
2007-009805	R1023	R-CHIP
2007-009805	R1024	R-CHIP
2007-009805	R1027	R-CHIP
2007-009805	R1028	R-CHIP
2007-009805	R2002	R-CHIP
2007-009805	R2009	R-CHIP
2007-009866	R10023	R-CHIP
2007-009866	R10024	R-CHIP
2007-009866	R10025	R-CHIP
2007-009866	R10026	R-CHIP
2007-009866	R6015	R-CHIP
2007-009920	R3040	R-CHIP
2007-009920	R3041	R-CHIP
2007-009920	R3043	R-CHIP
2007-009920	R3044	R-CHIP
2007-009920	R3045	R-CHIP
2007-009920	R3046	R-CHIP
2007-009969	R6006	R-CHIP
2007-010202	R5038	R-CHIP
2007-010202	R6005	R-CHIP
2007-010202	R7000	R-CHIP
2007-010202	R7001	R-CHIP
2007-010202	R8006	R-CHIP
2007-010685	R1015	R-CHIP
2007-010685	R1020	R-CHIP
2007-010685	R2003	R-CHIP
2007-010685	R2010	R-CHIP
2007-010856	R5057	R-CHIP
2007-011648	R10003	R-CHIP
2007-011648	R10006	R-CHIP
2007-011648	R1022	R-CHIP
2007-011648	R5022	R-CHIP
2007-012033	R6000	R-CHIP
2203-000233	C10072	C-CER,CHIP
2203-000233	C10073	C-CER,CHIP
2203-000425	C10006	C-CER,CHIP
2203-000425	C10008	C-CER,CHIP
2203-000425	C10012	C-CER,CHIP
2203-000438	C10059	C-CER,CHIP

Confidential and proprietary-the contents in this service guide subject to change without prior notice

Distribution, transmission, or infringement of any content or data from this document without Samsung's written authorization is strictly prohibited.

5. MAIN Electrical Parts List

2203-000438	C10060	C-CER,CHIP
2203-000438	C6057	C-CER,CHIP
2203-000438	C6070	C-CER,CHIP
2203-000438	C6071	C-CER,CHIP
2203-000438	C6091	C-CER,CHIP
2203-000438	C6092	C-CER,CHIP
2203-000438	U6056	C-CER,CHIP
2203-000812	C8046	C-CER,CHIP
2203-001101	C5103	C-CER,CHIP
2203-001239	C10005	C-CER,CHIP
2203-001239	C10007	C-CER,CHIP
2203-001239	C10011	C-CER,CHIP
2203-001239	C5098	C-CER,CHIP
2203-002668	C1060	C-CER,CHIP
2203-003019	C5102	C-CER,CHIP
2203-005682	C1070	C-CER,CHIP
2203-005682	C1090	C-CER,CHIP
2203-005682	C1115	C-CER,CHIP
2203-005682	C1143	C-CER,CHIP
2203-005682	C1209	C-CER,CHIP
2203-005682	C6060	C-CER,CHIP
2203-005682	C6062	C-CER,CHIP
2203-005682	C7004	C-CER,CHIP
2203-005682	C7005	C-CER,CHIP
2203-005682	C7006	C-CER,CHIP
2203-005719	C1080	C-CER,CHIP
2203-005719	C2071	C-CER,CHIP
2203-005719	C8063	C-CER,CHIP
2203-005719	C8068	C-CER,CHIP
2203-005725	C2070	C-CER,CHIP
2203-005725	C6050	C-CER,CHIP
2203-005725	C8003	C-CER,CHIP
2203-005725	C8019	C-CER,CHIP
2203-005726	C6068	C-CER,CHIP
2203-005726	C6069	C-CER,CHIP
2203-005727	C1129	C-CER,CHIP
2203-005727	L1123	C-CER,CHIP
2203-005729	C1212	C-CER,CHIP
2203-005729	C2038	C-CER,CHIP
2203-005729	C6020	C-CER,CHIP

Confidential and proprietary-the contents in this service guide subject to change without prior notice

Distribution, transmission, or infringement of any content or data from this document without Samsung's written authorization is strictly prohibited.

5. MAIN Electrical Parts List

2203-005729	C6023	C-CER,CHIP
2203-005731	C1157	C-CER,CHIP
2203-005731	C6055	C-CER,CHIP
2203-005731	C6056	C-CER,CHIP
2203-005731	L1089	C-CER,CHIP
2203-005732	C1206	C-CER,CHIP
2203-005732	C5104	C-CER,CHIP
2203-005732	C6024	C-CER,CHIP
2203-005732	C6053	C-CER,CHIP
2203-005732	C6054	C-CER,CHIP
2203-005732	C8017	C-CER,CHIP
2203-005732	L1139	C-CER,CHIP
2203-005736	C1000	C-CER,CHIP
2203-005736	C1001	C-CER,CHIP
2203-005736	C10032	C-CER,CHIP
2203-005736	C10037	C-CER,CHIP
2203-005736	C10049	C-CER,CHIP
2203-005736	C10064	C-CER,CHIP
2203-005736	C1025	C-CER,CHIP
2203-005736	C1057	C-CER,CHIP
2203-005736	C1101	C-CER,CHIP
2203-005736	C1102	C-CER,CHIP
2203-005736	C1125	C-CER,CHIP
2203-005736	C1147	C-CER,CHIP
2203-005736	C1148	C-CER,CHIP
2203-005736	C1149	C-CER,CHIP
2203-005736	C1152	C-CER,CHIP
2203-005736	C1170	C-CER,CHIP
2203-005736	C1192	C-CER,CHIP
2203-005736	C1199	C-CER,CHIP
2203-005736	C1216	C-CER,CHIP
2203-005736	C1217	C-CER,CHIP
2203-005736	C2005	C-CER,CHIP
2203-005736	C2020	C-CER,CHIP
2203-005736	C2025	C-CER,CHIP
2203-005736	C2035	C-CER,CHIP
2203-005736	C2036	C-CER,CHIP
2203-005736	C2037	C-CER,CHIP
2203-005736	C2040	C-CER,CHIP
2203-005736	C2042	C-CER,CHIP

Confidential and proprietary-the contents in this service guide subject to change without prior notice

Distribution, transmission, or infringement of any content or data from this document without Samsung's written authorization is strictly prohibited.

5. MAIN Electrical Parts List

2203-005736	C2066	C-CER,CHIP
2203-005736	C2067	C-CER,CHIP
2203-005736	C2069	C-CER,CHIP
2203-005736	C2075	C-CER,CHIP
2203-005736	C7037	C-CER,CHIP
2203-005736	C7045	C-CER,CHIP
2203-005736	C8026	C-CER,CHIP
2203-005736	C8045	C-CER,CHIP
2203-005736	L10017	C-CER,CHIP
2203-005736	L1045	C-CER,CHIP
2203-005736	L1066	C-CER,CHIP
2203-005736	L1098	C-CER,CHIP
2203-005736	L1108	C-CER,CHIP
2203-005736	L1120	C-CER,CHIP
2203-005736	L1152	C-CER,CHIP
2203-005740	C1008	C-CER,CHIP
2203-005740	C1200	C-CER,CHIP
2203-005740	C2009	C-CER,CHIP
2203-005740	C2027	C-CER,CHIP
2203-005740	L1136	C-CER,CHIP
2203-005742	C9009	C-CER,CHIP
2203-005742	C9010	C-CER,CHIP
2203-005777	C10042	C-CER,CHIP
2203-005777	C1048	C-CER,CHIP
2203-005777	L10020	C-CER,CHIP
2203-005777	L1032	C-CER,CHIP
2203-005777	L9000	C-CER,CHIP
2203-005779	C8000	C-CER,CHIP
2203-005789	C1041	C-CER,CHIP
2203-005789	C1043	C-CER,CHIP
2203-005789	C1059	C-CER,CHIP
2203-005789	C1127	C-CER,CHIP
2203-005789	C1160	C-CER,CHIP
2203-005789	L1029	C-CER,CHIP
2203-005789	L1068	C-CER,CHIP
2203-005789	L1083	C-CER,CHIP
2203-005792	C1042	C-CER,CHIP
2203-006048	C2015	C-CER,CHIP
2203-006048	C2031	C-CER,CHIP
2203-006048	C7023	C-CER,CHIP

Confidential and proprietary-the contents in this service guide subject to change without prior notice

Distribution, transmission, or infringement of any content or data from this document without Samsung's written authorization is strictly prohibited.

5. MAIN Electrical Parts List

2203-006048	C8036	C-CER,CHIP
2203-006121	C1179	C-CER,CHIP
2203-006121	C6022	C-CER,CHIP
2203-006123	C1028	C-CER,CHIP
2203-006123	C1201	C-CER,CHIP
2203-006123	C2034	C-CER,CHIP
2203-006123	C2082	C-CER,CHIP
2203-006123	L1080	C-CER,CHIP
2203-006187	C1204	C-CER,CHIP
2203-006187	L1079	C-CER,CHIP
2203-006187	L1121	C-CER,CHIP
2203-006194	C2045	C-CER,CHIP
2203-006194	C2046	C-CER,CHIP
2203-006194	C2048	C-CER,CHIP
2203-006194	C2050	C-CER,CHIP
2203-006194	C2051	C-CER,CHIP
2203-006194	C2052	C-CER,CHIP
2203-006194	C2059	C-CER,CHIP
2203-006194	C2060	C-CER,CHIP
2203-006194	C2062	C-CER,CHIP
2203-006194	C2063	C-CER,CHIP
2203-006194	C2064	C-CER,CHIP
2203-006194	C2065	C-CER,CHIP
2203-006305	C10017	C-CER,CHIP
2203-006305	C10030	C-CER,CHIP
2203-006305	C10036	C-CER,CHIP
2203-006305	C1122	C-CER,CHIP
2203-006305	C1187	C-CER,CHIP
2203-006305	C2018	C-CER,CHIP
2203-006305	L1047	C-CER,CHIP
2203-006305	L1055	C-CER,CHIP
2203-006305	L1119	C-CER,CHIP
2203-006318	C10015	C-CER,CHIP
2203-006379	C6093	C-CER,CHIP
2203-006399	C10024	C-CER,CHIP
2203-006399	C4047	C-CER,CHIP
2203-006399	C5109	C-CER,CHIP
2203-006399	C5150	C-CER,CHIP
2203-006399	C8014	C-CER,CHIP
2203-006399	C8025	C-CER,CHIP

Confidential and proprietary-the contents in this service guide subject to change without prior notice

Distribution, transmission, or infringement of any content or data from this document without Samsung's written authorization is strictly prohibited.

5. MAIN Electrical Parts List

2203-006400	C10003	C-CER,CHIP
2203-006400	C1120	C-CER,CHIP
2203-006400	C1197	C-CER,CHIP
2203-006400	C2039	C-CER,CHIP
2203-006400	C4086	C-CER,CHIP
2203-006400	C4087	C-CER,CHIP
2203-006400	C5033	C-CER,CHIP
2203-006400	C6081	C-CER,CHIP
2203-006400	C6082	C-CER,CHIP
2203-006400	C6083	C-CER,CHIP
2203-006400	C7003	C-CER,CHIP
2203-006400	C8042	C-CER,CHIP
2203-006400	C8051	C-CER,CHIP
2203-006400	C8054	C-CER,CHIP
2203-006400	C8055	C-CER,CHIP
2203-006400	C8062	C-CER,CHIP
2203-006400	U10117	C-CER,CHIP
2203-006410	C1006	C-CER,CHIP
2203-006410	C1093	C-CER,CHIP
2203-006410	L10019	C-CER,CHIP
2203-006423	C1004	C-CER,CHIP
2203-006423	C1005	C-CER,CHIP
2203-006423	C10050	C-CER,CHIP
2203-006423	C10051	C-CER,CHIP
2203-006423	C10067	C-CER,CHIP
2203-006423	C1012	C-CER,CHIP
2203-006423	C1014	C-CER,CHIP
2203-006423	C1018	C-CER,CHIP
2203-006423	C1019	C-CER,CHIP
2203-006423	C1020	C-CER,CHIP
2203-006423	C1023	C-CER,CHIP
2203-006423	C1034	C-CER,CHIP
2203-006423	C1035	C-CER,CHIP
2203-006423	C1036	C-CER,CHIP
2203-006423	C1037	C-CER,CHIP
2203-006423	C1038	C-CER,CHIP
2203-006423	C1039	C-CER,CHIP
2203-006423	C1049	C-CER,CHIP
2203-006423	C1050	C-CER,CHIP
2203-006423	C1119	C-CER,CHIP

Confidential and proprietary-the contents in this service guide subject to change without prior notice

Distribution, transmission, or infringement of any content or data from this document without Samsung's written authorization is strictly prohibited.

5. MAIN Electrical Parts List

2203-006423	C1121	C-CER,CHIP
2203-006423	C1138	C-CER,CHIP
2203-006423	C1202	C-CER,CHIP
2203-006423	C1203	C-CER,CHIP
2203-006423	C2019	C-CER,CHIP
2203-006423	C2033	C-CER,CHIP
2203-006423	C4004	C-CER,CHIP
2203-006423	C5118	C-CER,CHIP
2203-006423	C5119	C-CER,CHIP
2203-006423	C5132	C-CER,CHIP
2203-006423	C6008	C-CER,CHIP
2203-006423	C6009	C-CER,CHIP
2203-006423	C6010	C-CER,CHIP
2203-006423	C6011	C-CER,CHIP
2203-006423	C6012	C-CER,CHIP
2203-006423	C6015	C-CER,CHIP
2203-006423	C6016	C-CER,CHIP
2203-006423	C6017	C-CER,CHIP
2203-006423	C6021	C-CER,CHIP
2203-006423	C6027	C-CER,CHIP
2203-006423	C6028	C-CER,CHIP
2203-006423	C6031	C-CER,CHIP
2203-006423	C6032	C-CER,CHIP
2203-006423	C6034	C-CER,CHIP
2203-006423	C6037	C-CER,CHIP
2203-006423	C6045	C-CER,CHIP
2203-006423	C7001	C-CER,CHIP
2203-006423	C7002	C-CER,CHIP
2203-006423	C7010	C-CER,CHIP
2203-006423	C7011	C-CER,CHIP
2203-006423	C7012	C-CER,CHIP
2203-006423	C7013	C-CER,CHIP
2203-006423	C7014	C-CER,CHIP
2203-006423	C7015	C-CER,CHIP
2203-006423	C7016	C-CER,CHIP
2203-006423	C7017	C-CER,CHIP
2203-006423	C7020	C-CER,CHIP
2203-006423	C7025	C-CER,CHIP
2203-006423	C7026	C-CER,CHIP
2203-006423	C7032	C-CER,CHIP

Confidential and proprietary-the contents in this service guide subject to change without prior notice

Distribution, transmission, or infringement of any content or data from this document without Samsung's written authorization is strictly prohibited.

5. MAIN Electrical Parts List

2203-006423	C7033	C-CER,CHIP
2203-006423	C8016	C-CER,CHIP
2203-006423	C8059	C-CER,CHIP
2203-006423	C9016	C-CER,CHIP
2203-006556	C1072	C-CER,CHIP
2203-006556	C1084	C-CER,CHIP
2203-006556	C8006	C-CER,CHIP
2203-006562	C10071	C-CER,CHIP
2203-006562	C2014	C-CER,CHIP
2203-006562	C2030	C-CER,CHIP
2203-006562	C5085	C-CER,CHIP
2203-006562	C5086	C-CER,CHIP
2203-006562	C6107	C-CER,CHIP
2203-006562	C6108	C-CER,CHIP
2203-006562	C6109	C-CER,CHIP
2203-006562	C8024	C-CER,CHIP
2203-006562	C8029	C-CER,CHIP
2203-006562	C8031	C-CER,CHIP
2203-006562	C8035	C-CER,CHIP
2203-006604	C7030	C-CER,CHIP
2203-006604	L1132	C-CER,CHIP
2203-006611	C1186	C-CER,CHIP
2203-006611	L2013	C-CER,CHIP
2203-006611	L2043	C-CER,CHIP
2203-006642	C8001	C-CER,CHIP
2203-006647	C10074	C-CER,CHIP
2203-006648	C7038	C-CER,CHIP
2203-006648	C7046	C-CER,CHIP
2203-006665	C1066	C-CER,CHIP
2203-006665	C7031	C-CER,CHIP
2203-006665	L2055	C-CER,CHIP
2203-006674	C1116	C-CER,CHIP
2203-006674	C1210	C-CER,CHIP
2203-006674	L10018	C-CER,CHIP
2203-006707	C1073	C-CER,CHIP
2203-006839	C10065	C-CER,CHIP
2203-006839	C5077	C-CER,CHIP
2203-006839	C6000	C-CER,CHIP
2203-006839	C6005	C-CER,CHIP
2203-006839	C6006	C-CER,CHIP

Confidential and proprietary-the contents in this service guide subject to change without prior notice

Distribution, transmission, or infringement of any content or data from this document without Samsung's written authorization is strictly prohibited.

5. MAIN Electrical Parts List

2203-006839	C6096	C-CER,CHIP
2203-006839	C6097	C-CER,CHIP
2203-006839	C6098	C-CER,CHIP
2203-006844	C10046	C-CER,CHIP
2203-006844	C10048	C-CER,CHIP
2203-006844	C10052	C-CER,CHIP
2203-006844	C10054	C-CER,CHIP
2203-006846	C1114	C-CER,CHIP
2203-006846	C2080	C-CER,CHIP
2203-006846	C2081	C-CER,CHIP
2203-006872	C8044	C-CER,CHIP
2203-006872	C8047	C-CER,CHIP
2203-006872	C8052	C-CER,CHIP
2203-006978	C4100	C-CER,CHIP
2203-006978	C5143	C-CER,CHIP
2203-006978	C5144	C-CER,CHIP
2203-007143	C5124	C-CER,CHIP
2203-007194	C1103	C-CER,CHIP
2203-007194	C1113	C-CER,CHIP
2203-007194	C1135	C-CER,CHIP
2203-007194	C6040	C-CER,CHIP
2203-007194	C6041	C-CER,CHIP
2203-007194	L1096	C-CER,CHIP
2203-007210	C1003	C-CER,CHIP
2203-007210	C1013	C-CER,CHIP
2203-007210	C1016	C-CER,CHIP
2203-007210	C1017	C-CER,CHIP
2203-007210	C1022	C-CER,CHIP
2203-007210	C1024	C-CER,CHIP
2203-007210	C1033	C-CER,CHIP
2203-007210	C1044	C-CER,CHIP
2203-007210	C2061	C-CER,CHIP
2203-007210	C4014	C-CER,CHIP
2203-007210	C4024	C-CER,CHIP
2203-007210	C4071	C-CER,CHIP
2203-007210	C4072	C-CER,CHIP
2203-007210	C4080	C-CER,CHIP
2203-007210	C4098	C-CER,CHIP
2203-007210	C4101	C-CER,CHIP
2203-007210	U4006	C-CER,CHIP

Confidential and proprietary-the contents in this service guide subject to change without prior notice

Distribution, transmission, or infringement of any content or data from this document without Samsung's written authorization is strictly prohibited.

5. MAIN Electrical Parts List

2203-007240	C8048	C-CER,CHIP
2203-007240	C8049	C-CER,CHIP
2203-007269	C8033	C-CER,CHIP
2203-007269	C8034	C-CER,CHIP
2203-007269	C8037	C-CER,CHIP
2203-007269	C8038	C-CER,CHIP
2203-007269	C8039	C-CER,CHIP
2203-007269	C8040	C-CER,CHIP
2203-007271	C2058	C-CER,CHIP
2203-007271	C9004	C-CER,CHIP
2203-007271	C9005	C-CER,CHIP
2203-007279	C10000	C-CER,CHIP
2203-007279	C10002	C-CER,CHIP
2203-007279	C10009	C-CER,CHIP
2203-007279	C6064	C-CER,CHIP
2203-007279	C6067	C-CER,CHIP
2203-007279	C6072	C-CER,CHIP
2203-007279	C6073	C-CER,CHIP
2203-007279	C6075	C-CER,CHIP
2203-007279	C6076	C-CER,CHIP
2203-007279	C6078	C-CER,CHIP
2203-007279	C6080	C-CER,CHIP
2203-007279	C6099	C-CER,CHIP
2203-007279	C8069	C-CER,CHIP
2203-007279	C8070	C-CER,CHIP
2203-007317	C1011	C-CER,CHIP
2203-007317	C1015	C-CER,CHIP
2203-007317	C1021	C-CER,CHIP
2203-007317	C2044	C-CER,CHIP
2203-007317	C2049	C-CER,CHIP
2203-007317	C2053	C-CER,CHIP
2203-007317	C4076	C-CER,CHIP
2203-007317	C5043	C-CER,CHIP
2203-007317	C5044	C-CER,CHIP
2203-007317	C5046	C-CER,CHIP
2203-007317	C5067	C-CER,CHIP
2203-007317	C5069	C-CER,CHIP
2203-007317	C6035	C-CER,CHIP
2203-007317	C6036	C-CER,CHIP
2203-007317	C7041	C-CER,CHIP

Confidential and proprietary-the contents in this service guide subject to change without prior notice

Distribution, transmission, or infringement of any content or data from this document without Samsung's written authorization is strictly prohibited.

5. MAIN Electrical Parts List

2203-007317	C8008	C-CER,CHIP
2203-007317	C8009	C-CER,CHIP
2203-007391	C1118	C-CER,CHIP
2203-007391	C1137	C-CER,CHIP
2203-007391	C1139	C-CER,CHIP
2203-007391	C1162	C-CER,CHIP
2203-007391	C1163	C-CER,CHIP
2203-007391	C1198	C-CER,CHIP
2203-007391	C2054	C-CER,CHIP
2203-007391	C2056	C-CER,CHIP
2203-007391	C2057	C-CER,CHIP
2203-007391	C6003	C-CER,CHIP
2203-007391	C6014	C-CER,CHIP
2203-007391	C6030	C-CER,CHIP
2203-007391	C6043	C-CER,CHIP
2203-007391	C6044	C-CER,CHIP
2203-007391	C9008	C-CER,CHIP
2203-007392	C5006	C-CER,CHIP
2203-007392	C5032	C-CER,CHIP
2203-007392	C5036	C-CER,CHIP
2203-007392	C5101	C-CER,CHIP
2203-007392	C5114	C-CER,CHIP
2203-007392	C5136	C-CER,CHIP
2203-007392	C8053	C-CER,CHIP
2203-007393	C5082	C-CER,CHIP
2203-007393	C5083	C-CER,CHIP
2203-007393	C5115	C-CER,CHIP
2203-007393	C6007	C-CER,CHIP
2203-007393	C6039	C-CER,CHIP
2203-007393	C7034	C-CER,CHIP
2203-007393	C7039	C-CER,CHIP
2203-007393	C8027	C-CER,CHIP
2203-007393	C9019	C-CER,CHIP
2203-007456	C5030	C-CER,CHIP
2203-007456	C5031	C-CER,CHIP
2203-007456	C5116	C-CER,CHIP
2203-007456	C5134	C-CER,CHIP
2203-007456	C5135	C-CER,CHIP
2203-007456	C5137	C-CER,CHIP
2203-007456	C5146	C-CER,CHIP

Confidential and proprietary-the contents in this service guide subject to change without prior notice

Distribution, transmission, or infringement of any content or data from this document without Samsung's written authorization is strictly prohibited.

5. MAIN Electrical Parts List

2203-007456	C5148	C-CER,CHIP
2203-007486	C5117	C-CER,CHIP
2203-007781	C10004	C-CER,CHIP
2203-007781	C5087	C-CER,CHIP
2203-007781	C5099	C-CER,CHIP
2203-007781	C5100	C-CER,CHIP
2203-007781	C6086	C-CER,CHIP
2203-007781	C6087	C-CER,CHIP
2203-007781	C6088	C-CER,CHIP
2203-007796	C1089	C-CER,CHIP
2203-007796	C1108	C-CER,CHIP
2203-007796	C1184	C-CER,CHIP
2203-007796	C4000	C-CER,CHIP
2203-007796	C4001	C-CER,CHIP
2203-007796	C4007	C-CER,CHIP
2203-007796	C4008	C-CER,CHIP
2203-007796	C4009	C-CER,CHIP
2203-007796	C4010	C-CER,CHIP
2203-007796	C4011	C-CER,CHIP
2203-007796	C4020	C-CER,CHIP
2203-007796	C4021	C-CER,CHIP
2203-007796	C4022	C-CER,CHIP
2203-007796	C4023	C-CER,CHIP
2203-007796	C4028	C-CER,CHIP
2203-007796	C4035	C-CER,CHIP
2203-007796	C4036	C-CER,CHIP
2203-007796	C4037	C-CER,CHIP
2203-007796	C4038	C-CER,CHIP
2203-007796	C4039	C-CER,CHIP
2203-007796	C4040	C-CER,CHIP
2203-007796	C4042	C-CER,CHIP
2203-007796	C4043	C-CER,CHIP
2203-007796	C4048	C-CER,CHIP
2203-007796	C4049	C-CER,CHIP
2203-007796	C4050	C-CER,CHIP
2203-007796	C4051	C-CER,CHIP
2203-007796	C4053	C-CER,CHIP
2203-007796	C4055	C-CER,CHIP
2203-007796	C4056	C-CER,CHIP
2203-007796	C4057	C-CER,CHIP

Confidential and proprietary-the contents in this service guide subject to change without prior notice

Distribution, transmission, or infringement of any content or data from this document without Samsung's written authorization is strictly prohibited.

5. MAIN Electrical Parts List

2203-007796	C4058	C-CER,CHIP
2203-007796	C4066	C-CER,CHIP
2203-007796	C4067	C-CER,CHIP
2203-007796	C4068	C-CER,CHIP
2203-007796	C4073	C-CER,CHIP
2203-007796	C4074	C-CER,CHIP
2203-007796	C4075	C-CER,CHIP
2203-007796	C4092	C-CER,CHIP
2203-007796	C4093	C-CER,CHIP
2203-007796	C4094	C-CER,CHIP
2203-007796	C4099	C-CER,CHIP
2203-007796	C5056	C-CER,CHIP
2203-007796	C5064	C-CER,CHIP
2203-007796	C5068	C-CER,CHIP
2203-007796	C5074	C-CER,CHIP
2203-007796	C5081	C-CER,CHIP
2203-007796	C6004	C-CER,CHIP
2203-007796	C6019	C-CER,CHIP
2203-007796	C6038	C-CER,CHIP
2203-007796	C7008	C-CER,CHIP
2203-007796	C7027	C-CER,CHIP
2203-007796	C8030	C-CER,CHIP
2203-007796	C8032	C-CER,CHIP
2203-008097	C10025	C-CER,CHIP
2203-008097	C10045	C-CER,CHIP
2203-008097	C10047	C-CER,CHIP
2203-008097	C10053	C-CER,CHIP
2203-008097	C10055	C-CER,CHIP
2203-008097	C1077	C-CER,CHIP
2203-008097	C1078	C-CER,CHIP
2203-008097	C1085	C-CER,CHIP
2203-008097	C3001	C-CER,CHIP
2203-008097	C3002	C-CER,CHIP
2203-008097	C4069	C-CER,CHIP
2203-008097	C4070	C-CER,CHIP
2203-008097	C4081	C-CER,CHIP
2203-008097	C5020	C-CER,CHIP
2203-008097	C5028	C-CER,CHIP
2203-008097	C6059	C-CER,CHIP
2203-008097	C6061	C-CER,CHIP

Confidential and proprietary-the contents in this service guide subject to change without prior notice

Distribution, transmission, or infringement of any content or data from this document without Samsung's written authorization is strictly prohibited.

5. MAIN Electrical Parts List

2203-008158	C5049	C-CER,CHIP
2203-008158	C5075	C-CER,CHIP
2203-008158	C5138	C-CER,CHIP
2203-008242	C4002	C-CER,CHIP
2203-008242	C4003	C-CER,CHIP
2203-008242	C4085	C-CER,CHIP
2203-008242	C5053	C-CER,CHIP
2203-008242	C5054	C-CER,CHIP
2203-008242	C5055	C-CER,CHIP
2203-008242	C5065	C-CER,CHIP
2203-008242	C5072	C-CER,CHIP
2203-008242	C5073	C-CER,CHIP
2203-008242	C8005	C-CER,CHIP
2203-008243	C5125	C-CER,CHIP
2203-008243	C5131	C-CER,CHIP
2203-008243	C5133	C-CER,CHIP
2203-008243	C5145	C-CER,CHIP
2203-008243	C5147	C-CER,CHIP
2203-008243	C8007	C-CER,CHIP
2203-008394	C1002	C-CER,CHIP
2203-008394	C10029	C-CER,CHIP
2203-008394	C1156	C-CER,CHIP
2203-008394	L1088	C-CER,CHIP
2203-008529	C1107	C-CER,CHIP
2203-008529	C1182	C-CER,CHIP
2203-008529	C2010	C-CER,CHIP
2203-008529	C2028	C-CER,CHIP
2203-008529	C5038	C-CER,CHIP
2203-008529	C5041	C-CER,CHIP
2203-008529	C5042	C-CER,CHIP
2203-008529	C5078	C-CER,CHIP
2203-008529	C5097	C-CER,CHIP
2203-008529	C5140	C-CER,CHIP
2203-008529	C6051	C-CER,CHIP
2203-008529	C8020	C-CER,CHIP
2203-008529	C8021	C-CER,CHIP
2203-008529	C8023	C-CER,CHIP
2203-008572	C5037	C-CER,CHIP
2203-008572	C5051	C-CER,CHIP
2203-008572	C5052	C-CER,CHIP

Confidential and proprietary-the contents in this service guide subject to change without prior notice

Distribution, transmission, or infringement of any content or data from this document without Samsung's written authorization is strictly prohibited.

5. MAIN Electrical Parts List

2203-008572	C5139	C-CER,CHIP
2203-008572	C5151	C-CER,CHIP
2203-008860	C10022	C-CER,CHIP
2203-008860	C10023	C-CER,CHIP
2203-008860	C1088	C-CER,CHIP
2203-008860	C1168	C-CER,CHIP
2203-008860	C1176	C-CER,CHIP
2203-008860	C1177	C-CER,CHIP
2203-008860	C4025	C-CER,CHIP
2203-008860	C4026	C-CER,CHIP
2203-008860	C4041	C-CER,CHIP
2203-008860	C4084	C-CER,CHIP
2203-008860	C4095	C-CER,CHIP
2203-008860	C5016	C-CER,CHIP
2203-008860	C5026	C-CER,CHIP
2203-008860	C5079	C-CER,CHIP
2203-008860	C5080	C-CER,CHIP
2203-008860	C5095	C-CER,CHIP
2203-008860	C5108	C-CER,CHIP
2203-008860	C5149	C-CER,CHIP
2203-008860	C6001	C-CER,CHIP
2203-008860	C6002	C-CER,CHIP
2203-008860	C6013	C-CER,CHIP
2203-008860	C6018	C-CER,CHIP
2203-008860	C6026	C-CER,CHIP
2203-008860	C6029	C-CER,CHIP
2203-008860	C6033	C-CER,CHIP
2203-008860	C6048	C-CER,CHIP
2203-008860	C6094	C-CER,CHIP
2203-008860	C6095	C-CER,CHIP
2203-008860	C7007	C-CER,CHIP
2203-008860	C7028	C-CER,CHIP
2203-008860	C7051	C-CER,CHIP
2203-008860	C7052	C-CER,CHIP
2203-008860	C8043	C-CER,CHIP
2203-008860	C9006	C-CER,CHIP
2203-008860	C9007	C-CER,CHIP
2203-008860	C9012	C-CER,CHIP
2203-008860	C9013	C-CER,CHIP
2203-008860	C9014	C-CER,CHIP

Confidential and proprietary-the contents in this service guide subject to change without prior notice

Distribution, transmission, or infringement of any content or data from this document without Samsung's written authorization is strictly prohibited.

5. MAIN Electrical Parts List

2203-008860	C9015	C-CER,CHIP
2203-008860	C9018	C-CER,CHIP
2203-008876	C4052	C-CER,CHIP
2203-008876	C4054	C-CER,CHIP
2203-008876	C4077	C-CER,CHIP
2203-008876	C5004	C-CER,CHIP
2203-008876	C5007	C-CER,CHIP
2203-008876	C5010	C-CER,CHIP
2203-008876	C5011	C-CER,CHIP
2203-008876	C5012	C-CER,CHIP
2203-008876	C5013	C-CER,CHIP
2203-008876	C5014	C-CER,CHIP
2203-008876	C5015	C-CER,CHIP
2203-008876	C5017	C-CER,CHIP
2203-008876	C5018	C-CER,CHIP
2203-008876	C5019	C-CER,CHIP
2203-008876	C5021	C-CER,CHIP
2203-008876	C5022	C-CER,CHIP
2203-008876	C5023	C-CER,CHIP
2203-008876	C5024	C-CER,CHIP
2203-008876	C5025	C-CER,CHIP
2203-008876	C5057	C-CER,CHIP
2203-008876	C5058	C-CER,CHIP
2203-008876	C5060	C-CER,CHIP
2203-008876	C5061	C-CER,CHIP
2203-008876	C5062	C-CER,CHIP
2203-008876	C5063	C-CER,CHIP
2203-008876	C5066	C-CER,CHIP
2203-008876	C5070	C-CER,CHIP
2203-008876	C8004	C-CER,CHIP
2203-008876	C8022	C-CER,CHIP
2203-008876	C8028	C-CER,CHIP
2203-008876	C8058	C-CER,CHIP
2203-008876	C8066	C-CER,CHIP
2203-008876	C8067	C-CER,CHIP
2203-008886	C6049	C-CER,CHIP
2203-009064	C4016	C-CER,CHIP
2203-009064	C4017	C-CER,CHIP
2203-009064	C4018	C-CER,CHIP
2203-009064	C4019	C-CER,CHIP

Confidential and proprietary-the contents in this service guide subject to change without prior notice

Distribution, transmission, or infringement of any content or data from this document without Samsung's written authorization is strictly prohibited.

5. MAIN Electrical Parts List

2203-009064	C4032	C-CER,CHIP
2203-009064	C4033	C-CER,CHIP
2203-009064	C4034	C-CER,CHIP
2203-009064	C4063	C-CER,CHIP
2203-009223	C10035	C-CER,CHIP
2203-009223	C10040	C-CER,CHIP
2203-009223	C1054	C-CER,CHIP
2203-009223	C1079	C-CER,CHIP
2203-009223	C1097	C-CER,CHIP
2203-009223	C1100	C-CER,CHIP
2203-009223	C7022	C-CER,CHIP
2203-009223	C7024	C-CER,CHIP
2203-009223	C9001	C-CER,CHIP
2203-009223	C9002	C-CER,CHIP
2203-009328	C2068	C-CER,CHIP
2203-009328	C5088	C-CER,CHIP
2203-009328	C5090	C-CER,CHIP
2203-009328	C5091	C-CER,CHIP
2203-009328	C5094	C-CER,CHIP
2203-009444	C5034	C-CER,CHIP
2203-009537	C4012	C-CER,CHIP
2203-009537	C4013	C-CER,CHIP
2203-009537	C4062	C-CER,CHIP
2203-009618	C5035	C-CER,CHIP
2203-009618	C5096	C-CER,CHIP
2203-009618	C5141	C-CER,CHIP
2203-009732	C5089	C-CER,CHIP
2203-009732	C5092	C-CER,CHIP
2203-009732	C5093	C-CER,CHIP
2203-009733	C1040	C-CER,CHIP
2203-009733	C1086	C-CER,CHIP
2203-009733	C1164	C-CER,CHIP
2203-009733	C1165	C-CER,CHIP
2203-009733	C1166	C-CER,CHIP
2203-009733	C1167	C-CER,CHIP
2203-009733	C2043	C-CER,CHIP
2203-009733	C2047	C-CER,CHIP
2203-009733	C2055	C-CER,CHIP
2203-009733	C4078	C-CER,CHIP
2203-009733	C4079	C-CER,CHIP

Confidential and proprietary-the contents in this service guide subject to change without prior notice

Distribution, transmission, or infringement of any content or data from this document without Samsung's written authorization is strictly prohibited.

5. MAIN Electrical Parts List

2203-009733	C6052	C-CER,CHIP
2203-009733	C8015	C-CER,CHIP
2203-009733	C8018	C-CER,CHIP
2203-009734	C5122	C-CER,CHIP
2203-009734	C5123	C-CER,CHIP
2203-009735	C4027	C-CER,CHIP
2203-009735	C4029	C-CER,CHIP
2203-009735	C4030	C-CER,CHIP
2203-009735	C4031	C-CER,CHIP
2203-009735	C4059	C-CER,CHIP
2203-009735	C4060	C-CER,CHIP
2203-009735	C4061	C-CER,CHIP
2203-009736	C4091	C-CER,CHIP
2203-009736	C5045	C-CER,CHIP
2203-009736	C5047	C-CER,CHIP
2203-009736	C5048	C-CER,CHIP
2203-009736	C5071	C-CER,CHIP
2203-009742	C4005	C-CER,CHIP
2203-009742	C4006	C-CER,CHIP
2203-009858	C1161	C-CER,CHIP
2203-009858	C5050	C-CER,CHIP
2203-009858	C5113	C-CER,CHIP
2203-009858	C5142	C-CER,CHIP
2203-009859	C5000	C-CER,CHIP
2203-009859	C5001	C-CER,CHIP
2203-009859	C5002	C-CER,CHIP
2203-009859	C5003	C-CER,CHIP
2203-009859	C5005	C-CER,CHIP
2203-009859	C5008	C-CER,CHIP
2203-009859	C5009	C-CER,CHIP
2203-009859	C5029	C-CER,CHIP
2203-009859	C5039	C-CER,CHIP
2203-009859	C5040	C-CER,CHIP
2203-009859	C5084	C-CER,CHIP
2203-009859	C5120	C-CER,CHIP
2203-009859	C5121	C-CER,CHIP
2703-001728	L10016	INDUCTOR-SMD
2703-002313	L1041	INDUCTOR-SMD
2703-002649	L1059	INDUCTOR-SMD
2703-002649	L1114	INDUCTOR-SMD

Confidential and proprietary-the contents in this service guide subject to change without prior notice

Distribution, transmission, or infringement of any content or data from this document without Samsung's written authorization is strictly prohibited.

5. MAIN Electrical Parts List

2703-002649	L1122	INDUCTOR-SMD
2703-002649	L2036	INDUCTOR-SMD
2703-002649	L2047	INDUCTOR-SMD
2703-002900	C1061	INDUCTOR-SMD
2703-002900	L1135	INDUCTOR-SMD
2703-002900	L7010	INDUCTOR-SMD
2703-002901	C1159	INDUCTOR-SMD
2703-002903	C1174	INDUCTOR-SMD
2703-002903	C1178	INDUCTOR-SMD
2703-002903	L10011	INDUCTOR-SMD
2703-002903	L2052	INDUCTOR-SMD
2703-002903	L7016	INDUCTOR-SMD
2703-002955	L2058	INDUCTOR-SMD
2703-002958	L10027	INDUCTOR-SMD
2703-002958	L10028	INDUCTOR-SMD
2703-002958	L1020	INDUCTOR-SMD
2703-002958	L1028	INDUCTOR-SMD
2703-002958	L1031	INDUCTOR-SMD
2703-002958	L1071	INDUCTOR-SMD
2703-002958	L1101	INDUCTOR-SMD
2703-002958	L1143	INDUCTOR-SMD
2703-002958	L1144	INDUCTOR-SMD
2703-002958	L1145	INDUCTOR-SMD
2703-002958	L1146	INDUCTOR-SMD
2703-002958	L2007	INDUCTOR-SMD
2703-002958	L2033	INDUCTOR-SMD
2703-002959	C1211	INDUCTOR-SMD
2703-002959	L1060	INDUCTOR-SMD
2703-002959	L1070	INDUCTOR-SMD
2703-002959	L1078	INDUCTOR-SMD
2703-002959	L1141	INDUCTOR-SMD
2703-002959	L8002	INDUCTOR-SMD
2703-002959	L8003	INDUCTOR-SMD
2703-002961	L10006	INDUCTOR-SMD
2703-002961	L1002	INDUCTOR-SMD
2703-002961	L10021	INDUCTOR-SMD
2703-002961	L2010	INDUCTOR-SMD
2703-002961	L8006	INDUCTOR-SMD
2703-002999	C10038	INDUCTOR-SMD
2703-002999	L1019	INDUCTOR-SMD

Confidential and proprietary-the contents in this service guide subject to change without prior notice

Distribution, transmission, or infringement of any content or data from this document without Samsung's written authorization is strictly prohibited.

5. MAIN Electrical Parts List

2703-002999	L1138	INDUCTOR-SMD
2703-003970	C1208	INDUCTOR-SMD
2703-004000	L1097	INDUCTOR-SMD
2703-004000	L2049	INDUCTOR-SMD
2703-004013	C1123	INDUCTOR-SMD
2703-004013	C1130	INDUCTOR-SMD
2703-004013	C1151	INDUCTOR-SMD
2703-004013	C2017	INDUCTOR-SMD
2703-004013	L1112	INDUCTOR-SMD
2703-004013	L1117	INDUCTOR-SMD
2703-004013	L2012	INDUCTOR-SMD
2703-004018	C1171	INDUCTOR-SMD
2703-004018	C9003	INDUCTOR-SMD
2703-004018	L1099	INDUCTOR-SMD
2703-004018	L2003	INDUCTOR-SMD
2703-004018	L9001	INDUCTOR-SMD
2703-004033	L1134	INDUCTOR-SMD
2703-004034	C1117	INDUCTOR-SMD
2703-004034	C1205	INDUCTOR-SMD
2703-004034	C2041	INDUCTOR-SMD
2703-004034	C2079	INDUCTOR-SMD
2703-004034	L1011	INDUCTOR-SMD
2703-004034	L1016	INDUCTOR-SMD
2703-004034	L1048	INDUCTOR-SMD
2703-004034	L1102	INDUCTOR-SMD
2703-004034	L2002	INDUCTOR-SMD
2703-004034	L2031	INDUCTOR-SMD
2703-004034	L2042	INDUCTOR-SMD
2703-004034	L2051	INDUCTOR-SMD
2703-004034	L2057	INDUCTOR-SMD
2703-004036	C1181	INDUCTOR-SMD
2703-004036	C1183	INDUCTOR-SMD
2703-004286	C1215	INDUCTOR-SMD
2703-004286	L2044	INDUCTOR-SMD
2703-004287	C2083	INDUCTOR-SMD
2703-004287	C9000	INDUCTOR-SMD
2703-004287	L1004	INDUCTOR-SMD
2703-004287	L1040	INDUCTOR-SMD
2703-004287	L1082	INDUCTOR-SMD
2703-004287	L1084	INDUCTOR-SMD

Confidential and proprietary-the contents in this service guide subject to change without prior notice

Distribution, transmission, or infringement of any content or data from this document without Samsung's written authorization is strictly prohibited.

5. MAIN Electrical Parts List

2703-004287	L2018	INDUCTOR-SMD
2703-004288	C1076	INDUCTOR-SMD
2703-004288	C1133	INDUCTOR-SMD
2703-004288	C1146	INDUCTOR-SMD
2703-004288	L1064	INDUCTOR-SMD
2703-004288	L1069	INDUCTOR-SMD
2703-004288	L1085	INDUCTOR-SMD
2703-004288	L1091	INDUCTOR-SMD
2703-004288	L1100	INDUCTOR-SMD
2703-004289	C1058	INDUCTOR-SMD
2703-004289	C1124	INDUCTOR-SMD
2703-004289	C1150	INDUCTOR-SMD
2703-004289	L1008	INDUCTOR-SMD
2703-004289	L1095	INDUCTOR-SMD
2703-004300	C2001	INDUCTOR-SMD
2703-004300	C2004	INDUCTOR-SMD
2703-004300	L1073	INDUCTOR-SMD
2703-004300	L1093	INDUCTOR-SMD
2703-004300	L1115	INDUCTOR-SMD
2703-004300	L2011	INDUCTOR-SMD
2703-004300	L2035	INDUCTOR-SMD
2703-004300	L2040	INDUCTOR-SMD
2703-004301	C2021	INDUCTOR-SMD
2703-004301	C2024	INDUCTOR-SMD
2703-004301	C2032	INDUCTOR-SMD
2703-004301	L1039	INDUCTOR-SMD
2703-004301	L1124	INDUCTOR-SMD
2703-004301	L2005	INDUCTOR-SMD
2703-004301	L2029	INDUCTOR-SMD
2703-004301	L2048	INDUCTOR-SMD
2703-004317	C2073	INDUCTOR-SMD
2703-004317	C2084	INDUCTOR-SMD
2703-004317	L1021	INDUCTOR-SMD
2703-004317	L2000	INDUCTOR-SMD
2703-004328	L2015	INDUCTOR-SMD
2703-004328	L2045	INDUCTOR-SMD
2703-004703	L7000	INDUCTOR-SMD
2703-004703	L7001	INDUCTOR-SMD
2703-004703	L7002	INDUCTOR-SMD
2703-004763	C1032	INDUCTOR-SMD

Confidential and proprietary-the contents in this service guide subject to change without prior notice

Distribution, transmission, or infringement of any content or data from this document without Samsung's written authorization is strictly prohibited.

5. MAIN Electrical Parts List

2703-004763	L1058	INDUCTOR-SMD
2703-004763	L1133	INDUCTOR-SMD
2703-004853	L10012	INDUCTOR-SMD
2703-004853	L1063	INDUCTOR-SMD
2703-004853	L1094	INDUCTOR-SMD
2703-004853	L2039	INDUCTOR-SMD
2703-004862	L1009	INDUCTOR-SMD
2703-004862	L1010	INDUCTOR-SMD
2703-004947	L10000	INDUCTOR-SMD
2703-004947	L6010	INDUCTOR-SMD
2703-004947	L6011	INDUCTOR-SMD
2703-004947	L6012	INDUCTOR-SMD
2703-004947	L8011	INDUCTOR-SMD
2703-005109	L5025	INDUCTOR-SMD
2703-005136	L5002	INDUCTOR-SMD
2703-005136	L5010	INDUCTOR-SMD
2703-005200	L6007	INDUCTOR-SMD
2703-005201	L5004	INDUCTOR-SMD
2703-005201	L5007	INDUCTOR-SMD
2703-005201	L5018	INDUCTOR-SMD
2703-005233	L6008	INDUCTOR-SMD
2703-005233	L6009	INDUCTOR-SMD
2703-005295	C1029	INDUCTOR-SMD
2703-005295	C1169	INDUCTOR-SMD
2703-005295	L1023	INDUCTOR-SMD
2703-005295	L1051	INDUCTOR-SMD
2703-005295	L1056	INDUCTOR-SMD
2703-005295	L1131	INDUCTOR-SMD
2703-005295	L1137	INDUCTOR-SMD
2703-005295	L1140	INDUCTOR-SMD
2703-005313	L8008	INDUCTOR-SMD
2703-005313	L8010	INDUCTOR-SMD
2703-005340	L1110	INDUCTOR-SMD
2703-005445	L1109	INDUCTOR-SMD
2703-005505	L5013	INDUCTOR-SMD
2703-005505	L5014	INDUCTOR-SMD
2703-005505	L8004	INDUCTOR-SMD
2703-005505	L8005	INDUCTOR-SMD
2703-005509	L5005	INDUCTOR-SMD
2703-005509	L5006	INDUCTOR-SMD

Confidential and proprietary-the contents in this service guide subject to change without prior notice

Distribution, transmission, or infringement of any content or data from this document without Samsung's written authorization is strictly prohibited.

5. MAIN Electrical Parts List

2703-005509	L5011	INDUCTOR-SMD
2703-005509	L5012	INDUCTOR-SMD
2703-005509	L5015	INDUCTOR-SMD
2703-005509	L5016	INDUCTOR-SMD
2703-005509	L5017	INDUCTOR-SMD
2703-005509	L5019	INDUCTOR-SMD
2703-005509	L5020	INDUCTOR-SMD
2703-005509	L5021	INDUCTOR-SMD
2703-005509	L5022	INDUCTOR-SMD
2703-005509	L5023	INDUCTOR-SMD
2703-005509	U5006	INDUCTOR-SMD
2801-005444	OSC9000	CRYSTAL-SMD
2801-005481	OSC5000	CRYSTAL-SMD
2901-001690	C4015	FILTER-EMI SMD
2901-001690	C4064	FILTER-EMI SMD
2901-001690	C4065	FILTER-EMI SMD
2901-001690	C4088	FILTER-EMI SMD
2901-001690	C4089	FILTER-EMI SMD
2901-001690	C4090	FILTER-EMI SMD
2903-001576	F2000	FILTER-CERAMIC
2903-001576	F2003	FILTER-CERAMIC
2904-002198	F1006	FILTER-SAW
2904-002347	F1008	FILTER-SAW
2904-002349	F1007	FILTER-SAW
2904-002356	F2007	FILTER SAW GPS
2904-002360	F2002	FILTER SAW WIFI
2904-002360	F2005	FILTER SAW WIFI
2911-000434	U1012	DUPLEXER-FEM
2911-000436	U1014	DUPLEXER-FEM
2911-000451	U1016	DUPLEXER ASM
2911-000453	U1011	DUPLEXER FEM
2911-000458	U1000	DUPLEXER FEM
2911-000463	U2003	DUPLEXER FEM WIFI
2911-000463	U2006	DUPLEXER FEM WIFI
3301-001534	L6000	BEAD-SMD
3301-001534	L6002	BEAD-SMD
3301-001789	L8014	BEAD-SMD
3301-001869	L6019	BEAD-SMD
3301-001885	L6003	BEAD-SMD
3301-001885	L6004	BEAD-SMD

Confidential and proprietary-the contents in this service guide subject to change without prior notice

Distribution, transmission, or infringement of any content or data from this document without Samsung's written authorization is strictly prohibited.

5. MAIN Electrical Parts List

3301-001901	L10015	BEAD-SMD
3301-002065	L10001	BEAD-SMD
3301-002078	L10029	BEAD-SMD
3301-002078	L7006	BEAD-SMD
3301-002085	L9002	BEAD-SMD
3301-002085	L9003	BEAD-SMD
3301-002122	L10024	BEAD-SMD
3301-002122	L10026	BEAD-SMD
3301-002122	L6013	BEAD-SMD
3301-002122	L6014	BEAD-SMD
3301-002122	L6015	BEAD-SMD
3301-002122	L6016	BEAD-SMD
3301-002122	L6017	BEAD-SMD
3301-002122	L6018	BEAD-SMD
3301-002223	L8000	BEAD-SMD
3301-002223	L8001	BEAD-SMD
3301-002223	L8013	BEAD-SMD
3301-002235	L10030	BEAD-SMD
3301-002235	L10031	BEAD-SMD
3301-002235	L1061	BEAD-SMD
3301-002235	L1062	BEAD-SMD
3301-002235	L1075	BEAD-SMD
3301-002235	L1087	BEAD-SMD
3301-002235	L1142	BEAD-SMD
3301-002235	L7008	BEAD-SMD
3301-002235	L7009	BEAD-SMD
3301-002237	L1001	BEAD-SMD
3301-002237	L1003	BEAD-SMD
3301-002237	L1005	BEAD-SMD
3301-002237	L1034	BEAD-SMD
3301-002237	L1046	BEAD-SMD
3301-002237	L1065	BEAD-SMD
3301-002237	L1081	BEAD-SMD
3301-002237	L2046	BEAD-SMD
3301-002237	L6001	BEAD-SMD
3301-002243	L1107	BEAD-SMD
3301-002244	L1104	BEAD-SMD
3301-002244	L8007	BEAD-SMD
3301-002244	L8009	BEAD-SMD
3301-002244	L8012	BEAD-SMD

Confidential and proprietary-the contents in this service guide subject to change without prior notice

Distribution, transmission, or infringement of any content or data from this document without Samsung's written authorization is strictly prohibited.

5. MAIN Electrical Parts List

3301-002279	L7012	BEAD-SMD
3301-002287	L7003	BEAD-SMD
3301-002331	L5001	BEAD-SMD
3301-002331	L5008	BEAD-SMD
3301-002331	L5009	BEAD-SMD
3301-002331	L5024	BEAD-SMD
3301-002356	L6005	BEAD-SMD
3301-002356	L6006	BEAD-SMD
3301-002356	U6007	BEAD-SMD
3705-001708	RFS1000	CONNECTOR-COAXIAL
3705-001708	RFS1001	CONNECTOR-COAXIAL
3705-001937	RFS10000	CONNECTOR-COAXIAL
3705-001937	RFS10001	CONNECTOR-COAXIAL
3705-001937	RFS10002	CONNECTOR-COAXIAL
3705-001937	RFS1002	CONNECTOR-COAXIAL
3705-001937	RFS1003	CONNECTOR-COAXIAL
3705-001937	RFS2001	CONNECTOR-COAXIAL
3705-001937	RFS2002	CONNECTOR-COAXIAL
3705-001937	RFS9000	CONNECTOR-COAXIAL
3711-007107	HEA8000	SOCKET-BOARD TO BOARD
3711-007295	HDC8001	HEADER-BOARD TO BOARD
3711-007810	HDC7001	HEADER-BOARD TO BOARD
3711-008161	HDC7000	HEADER-BOARD TO BOARD
3711-008741	HDC8000	HEADER-BOARD TO BOARD
3711-008847	BTC5000	CONNECTOR-BATTERY
3711-008847	HDC5000	CONNECTOR-BATTERY
3711-008997	HDC10000	HEADER-BOARD TO BOARD
3711-008997	HDC10001	HEADER-BOARD TO BOARD
3711-008997	HDC6001	HEADER-BOARD TO BOARD
3711-008997	HDC8003	HEADER-BOARD TO BOARD
3711-008997	HDC9002	HEADER-BOARD TO BOARD
3711-009302	HDC10002	HEADER-BOARD TO BOARD
3711-009302	HDC7002	HEADER-BOARD TO BOARD
3711-009302	HDC8004	HEADER-BOARD TO BOARD
3711-009302	HDC9001	HEADER-BOARD TO BOARD
3712-001604	ANT1000	CONNECTOR-TERMINAL
3712-001604	ANT1001	CONNECTOR-TERMINAL
3712-001604	ANT1002	CONNECTOR-TERMINAL
3712-001604	ANT1003	CONNECTOR-TERMINAL
3712-001604	ANT1004	CONNECTOR-TERMINAL

Confidential and proprietary-the contents in this service guide subject to change without prior notice

Distribution, transmission, or infringement of any content or data from this document without Samsung's written authorization is strictly prohibited.

5. MAIN Electrical Parts List

3712-001604	ANT6000	CONNECTOR-TERMINAL
3712-001604	ANT6001	CONNECTOR-TERMINAL
3712-001604	ANT6002	CONNECTOR-TERMINAL
3712-001604	ANT6003	CONNECTOR-TERMINAL
3712-001604	ANT6004	CONNECTOR-TERMINAL
3712-001604	ANT6005	CONNECTOR-TERMINAL
3712-001604	ANT6006	CONNECTOR-TERMINAL
3712-001604	ANT6007	CONNECTOR-TERMINAL
3712-001604	ANT6008	CONNECTOR-TERMINAL
3712-001604	ANT6009	CONNECTOR-TERMINAL
3712-001604	ANT6010	CONNECTOR-TERMINAL
3712-001604	ANT6011	CONNECTOR-TERMINAL
3712-001604	ANT6012	CONNECTOR-TERMINAL
3712-001604	ANT6013	CONNECTOR-TERMINAL
3712-001604	ANT9000	CONNECTOR-TERMINAL
3712-001604	ANT9001	CONNECTOR-TERMINAL
3712-001633	ANT10002	CONNECTOR-TERMINAL
3712-001633	ANT10004	CONNECTOR-TERMINAL
3712-001633	ANT10006	CONNECTOR-TERMINAL
3712-001633	ANT10007	CONNECTOR-TERMINAL
3712-001633	ANT10009	CONNECTOR-TERMINAL
3712-001633	ANT10010	CONNECTOR-TERMINAL
3712-001666	ANT7000	CONNECTOR-TERMINAL
3712-001666	ANT7001	CONNECTOR-TERMINAL
3712-001666	ANT7002	CONNECTOR-TERMINAL
3712-001666	ANT7003	CONNECTOR-TERMINAL
3722-004059	USB10000	JACK-USB
4709-002150	F2001	COUPLER-DIRECTION
4709-002150	F2004	COUPLER-DIRECTION
4709-002196	F1003	FREQ-DISTRIBUTER
4709-002285	DIF2000	FREQ-DISTRIBUTER
4709-002285	DIF2001	FREQ-DISTRIBUTER
4709-002484	F1000	FREQ-DISTRIBUTER
4709-002529	F1001	FREQ-DISTRIBUTER
GH41-05424A	-	PCB MAIN-SM-T835
GH60-00010A	U10043	CLIP-SM_G930F
GH60-00010A	U9006	CLIP-SM_G930F
GH62-00042A	CN8000	PAD GAP-SMD GASKET
GH63-10226A	SC2000	SHIELD-COVER DCDC
GH63-10570D	SC10001	SHIELD-CAN_COVER_D

Confidential and proprietary-the contents in this service guide subject to change without prior notice

Distribution, transmission, or infringement of any content or data from this document without Samsung's written authorization is strictly prohibited.

5. MAIN Electrical Parts List

GH63-10570D	SC2002	SHIELD-CAN_COVER_D
GH63-10570D	SC2015	SHIELD-CAN_COVER_D
GH63-14267A	SC10000	SHIELD-CAN NFC KOR
GH63-14267A	SC2004	SHIELD-CAN NFC KOR
GH63-15595A	SC2008	SHIELD-MAIN BOT IF PM
GH63-15596A	SC2005	SHIELD-MAIN BOT OCTA DCDC
GH63-15628A	SC2009	SHIELD-MAIN BOT RF1
GH63-15708A	SC2007	SHIELD-MAIN TOP RF2
GH63-15708A	SC2010	SHIELD-MAIN TOP RF2
GH98-42850A	SC2011	ASSY SHIELD CAN-MAIN BOT AP

5. MAIN Electrical Parts List

[SM-T830]

Parts Code	Design Loc	Part Name
0202-002125	R10008	SOLDER-SHORT
0202-002125	R10063	SOLDER-SHORT
0202-002125	R6035	SOLDER-SHORT
0202-002125	R6045	SOLDER-SHORT
0202-002125	R6046	SOLDER-SHORT
0202-002125	TP_UB4001	SOLDER-SHORT
0202-002125	U2013	SOLDER-SHORT
0202-002125	U2015	SOLDER-SHORT
0202-002126	R3051	SOLDER-SHORT
0202-002126	R3053	SOLDER-SHORT
0404-001250	D5000	DIODE-SCHOTTKY
0404-001250	D5006	DIODE-SCHOTTKY
0406-001506	D2000	DIODE-TVS
0406-001506	D2001	DIODE-TVS
0406-001506	D5003	DIODE-TVS
0406-001506	D7001	DIODE-TVS
0406-001506	ZD1002	DIODE-TVS
0406-001561	D10008	DIODE-TVS
0406-001709	D10006	DIODE-TVS
0406-001709	D10007	DIODE-TVS
0406-001728	ZD5000	DIODE-TVS
0406-001743	D7000	DIODE-TVS
0406-001743	D7003	DIODE-TVS
0406-001743	D7004	DIODE-TVS
0406-001743	D7005	DIODE-TVS
0406-001743	D7006	DIODE-TVS
0406-001743	D7007	DIODE-TVS
0406-001763	D7002	DIODE-TVS
0406-001763	D7008	DIODE-TVS
0406-001763	D7009	DIODE-TVS
0406-001763	D7010	DIODE-TVS
0406-001763	ZD1000	DIODE-TVS
0406-001780	D10000	DIODE-TVS
0406-001780	D10001	DIODE-TVS
0406-001780	D10002	DIODE-TVS
0406-001780	D10003	DIODE-TVS
0406-001781	D10004	DIODE-TVS
0406-001781	D10005	DIODE-TVS

Confidential and proprietary-the contents in this service guide subject to change without prior notice

Distribution, transmission, or infringement of any content or data from this document without Samsung's written authorization is strictly prohibited.

5. MAIN Electrical Parts List

0406-001781	ZD10013	DIODE-TVS
0406-001781	ZD10014	DIODE-TVS
0406-001797	D10015	DIODE-TVS
0406-001797	D10016	DIODE-TVS
0406-001797	D5005	DIODE-TVS
0406-001797	ZD10017	DIODE-TVS
0406-001797	ZD7007	DIODE-TVS
0406-001797	ZD7008	DIODE-TVS
0406-001804	ZD10001	DIODE-TVS
0406-001804	ZD10003	DIODE-TVS
0406-001804	ZD10004	DIODE-TVS
0406-001804	ZD10005	DIODE-TVS
0406-001804	ZD10006	DIODE-TVS
0406-001804	ZD10007	DIODE-TVS
0406-001804	ZD10008	DIODE-TVS
0406-001804	ZD10009	DIODE-TVS
0406-001804	ZD10010	DIODE-TVS
0406-001804	ZD10011	DIODE-TVS
0406-001808	D5004	DIODE-TVS
0406-001808	D7011	DIODE-TVS
0505-001883	TR5005	FET-SILICON
0505-002088	TR8000	FET-SILICON
0505-003234	TR5000	FET-SILICON
0505-003234	TR5002	FET-SILICON
0505-003234	TR5004	FET-SILICON
0505-003618	TR5003	FET-SILICON
0601-003702	LED8000	LED
0801-003435	U8002	IC-CMOS LOGIC
1001-001755	U10018	IC-ANALOG SWITCH
1001-002046	U10033	IC-RF SWITCH
1003-002951	U5032	IC-POWER DRIVER
1003-002965	U10025	IC-LEVEL DRIVER
1009-001070	U10003	IC-HALL EFFECT S/W
1009-001070	U7008	IC-HALL EFFECT S/W
1105-002900	UCP300UP	IC-DDR4 SDRAM
1107-002589	UME4000	IC-UNIVERSAL FLASH STORAGE
1201-003786	U2008	IC-GPS AMP
1201-004099	U10006	IC-AUDIO AMP
1201-004099	U6040	IC-AUDIO AMP
1201-004099	U6041	IC-AUDIO AMP

Confidential and proprietary-the contents in this service guide subject to change without prior notice

Distribution, transmission, or infringement of any content or data from this document without Samsung's written authorization is strictly prohibited.

5. MAIN Electrical Parts List

1201-004099	U6042	IC-AUDIO AMP
1203-007884	U8003	IC-DC/DC CONVERTER
1203-007884	U8004	IC-DC/DC CONVERTER
1203-008190	U7012	IC-POSI.FIXED REG.
1203-008217	U8015	IC-DC/DC CONVERTER
1203-008251	U5005	IC-POSI.FIXED REG.
1203-008251	U5017	IC-POSI.FIXED REG.
1203-008251	U8024	IC-POSI.FIXED REG.
1203-008322	U8005	IC-POSI.FIXED REG.
1203-008322	U8007	IC-POSI.FIXED REG.
1203-008468	U5012	IC-VOL. DETECTOR
1203-008468	U5013	IC-VOL. DETECTOR
1203-008475	U5001	IC-VOL. DETECTOR
1203-008698	U5002	IC-BATTERY
1203-008811	U5011	IC-DC/DC CONVERTER
1203-008850	U6008	IC-DC/DC CONVERTER
1203-008857	U10017	IC-POSI.FIXED REG.
1203-008865	U8001	IC-POSI.FIXED REG.
1203-008865	U8009	IC-POSI.FIXED REG.
1203-008867	U6002	IC-POSI.FIXED REG.
1203-008867	U6057	IC-POSI.FIXED REG.
1203-008867	U7003	IC-POSI.FIXED REG.
1203-008867	U7019	IC-POSI.FIXED REG.
1203-008903	U8023	IC-DC/DC CONVERTER
1203-008904	U5009	IC-POWER SUPERVISOR
1203-008930	U5010	IC-POWER SUPERVISOR
1203-008931	U5000	IC-POWER SUPERVISOR
1203-008940	U5024	IC-DC/DC CONVERTER
1203-008948	U6000	IC-POSI.FIXED REG.
1203-008955	U8008	IC-POSI.FIXED REG.
1203-009054	U5021	IC-VOL. DETECTOR
1204-003765	U6005	IC-AUDIO PROCESSOR
1205-005651	U9005	IC-TOUCH
1205-005745	U6009	IC-CODEC
1205-005746	UCP300	IC-MODEM
1205-005821	U2010	IC-WIFI
1205-005954	U1006	IC-TRANSCEIVER
1209-002450	U7009	IC-ACCEL./GYRO SENSOR
1209-002513	U7010	IC-MAGNETIC SENSOR
1301-002183	U5028	IC-FPGA

Confidential and proprietary-the contents in this service guide subject to change without prior notice

Distribution, transmission, or infringement of any content or data from this document without Samsung's written authorization is strictly prohibited.

5. MAIN Electrical Parts List

1404-001664	TH10000	THERMISTOR-NTC
1404-001724	TH2000	THERMISTOR-NTC
1404-001724	TH3000	THERMISTOR-NTC
1404-001724	TH5000	THERMISTOR-NTC
1404-001724	TH5001	THERMISTOR-NTC
1404-001724	TH5010	THERMISTOR-NTC
1405-001395	V10002	VARISTOR
1405-001395	V10003	VARISTOR
1405-001404	VR8000	VARISTOR
1405-001412	VR1001	VARISTOR
1405-001433	VR10000	VARISTOR
1405-001433	VR10003	VARISTOR
1405-001433	VR1003	VARISTOR
1405-001433	VR1005	VARISTOR
1405-001433	VR9000	VARISTOR
1405-001433	VR9001	VARISTOR
2007-003015	R10021	R-CHIP
2007-003015	R10022	R-CHIP
2007-007014	R2017	R-CHIP
2007-007107	R5001	R-CHIP
2007-007107	R5027	R-CHIP
2007-007107	R5028	R-CHIP
2007-007107	R5037	R-CHIP
2007-007107	R5047	R-CHIP
2007-007107	R5058	R-CHIP
2007-007107	R5081	R-CHIP
2007-007107	R6014	R-CHIP
2007-007107	R6016	R-CHIP
2007-007107	R8004	R-CHIP
2007-007107	R8011	R-CHIP
2007-007107	R8012	R-CHIP
2007-007107	R8013	R-CHIP
2007-007107	R9003	R-CHIP
2007-007107	R9007	R-CHIP
2007-007142	R10004	R-CHIP
2007-007142	R10005	R-CHIP
2007-007142	R5000	R-CHIP
2007-007142	R5025	R-CHIP
2007-007142	R5026	R-CHIP
2007-007142	R5030	R-CHIP

Confidential and proprietary-the contents in this service guide subject to change without prior notice

Distribution, transmission, or infringement of any content or data from this document without Samsung's written authorization is strictly prohibited.

5. MAIN Electrical Parts List

2007-007142	R5032	R-CHIP
2007-007142	R5033	R-CHIP
2007-007142	R5041	R-CHIP
2007-007142	R6037	R-CHIP
2007-007142	R7005	R-CHIP
2007-007142	R8008	R-CHIP
2007-007142	R8014	R-CHIP
2007-007142	R8036	R-CHIP
2007-007193	R10012	R-CHIP
2007-007193	R10015	R-CHIP
2007-007308	R8035	R-CHIP
2007-007309	R8031	R-CHIP
2007-007318	R4000	R-CHIP
2007-007318	R5010	R-CHIP
2007-007517	R5042	R-CHIP
2007-007517	R5043	R-CHIP
2007-007573	R7011	R-CHIP
2007-007741	R5035	R-CHIP
2007-007741	R5045	R-CHIP
2007-007741	R6036	R-CHIP
2007-007741	R7024	R-CHIP
2007-007741	R8009	R-CHIP
2007-007798	R5007	R-CHIP
2007-007942	R5014	R-CHIP
2007-007946	R5015	R-CHIP
2007-008043	R2005	R-CHIP
2007-008043	R2012	R-CHIP
2007-008210	R2004	R-CHIP
2007-008210	R2011	R-CHIP
2007-008263	R3037	R-CHIP
2007-008263	R3038	R-CHIP
2007-008298	R2014	R-CHIP
2007-008420	R2019	R-CHIP
2007-008420	R2043	R-CHIP
2007-008420	R8002	R-CHIP
2007-008531	R10009	R-CHIP
2007-008531	R5016	R-CHIP
2007-008531	R8000	R-CHIP
2007-008531	R8001	R-CHIP
2007-008587	R6007	R-CHIP

Confidential and proprietary-the contents in this service guide subject to change without prior notice

Distribution, transmission, or infringement of any content or data from this document without Samsung's written authorization is strictly prohibited.

5. MAIN Electrical Parts List

2007-008686	R2001	R-CHIP
2007-008686	R2008	R-CHIP
2007-008766	R3055	R-CHIP
2007-008766	R3056	R-CHIP
2007-008774	R10027	R-CHIP
2007-008774	R10028	R-CHIP
2007-008774	R10029	R-CHIP
2007-008774	R10030	R-CHIP
2007-008774	R10031	R-CHIP
2007-008774	R10032	R-CHIP
2007-008774	R10041	R-CHIP
2007-008774	R10042	R-CHIP
2007-008774	R7014	R-CHIP
2007-008774	R7015	R-CHIP
2007-008774	R7016	R-CHIP
2007-008774	R7017	R-CHIP
2007-008774	R7018	R-CHIP
2007-008774	R7019	R-CHIP
2007-008774	R7020	R-CHIP
2007-008774	R7022	R-CHIP
2007-008798	R7012	R-CHIP
2007-008808	R5006	R-CHIP
2007-009111	R2000	R-CHIP
2007-009111	R2007	R-CHIP
2007-009111	R7027	R-CHIP
2007-009154	R3026	R-CHIP
2007-009155	R5040	R-CHIP
2007-009157	R3039	R-CHIP
2007-009157	R3042	R-CHIP
2007-009157	R5034	R-CHIP
2007-009157	R5036	R-CHIP
2007-009157	R5039	R-CHIP
2007-009158	R5009	R-CHIP
2007-009201	R6009	R-CHIP
2007-009201	R6010	R-CHIP
2007-009201	R6011	R-CHIP
2007-009201	R6012	R-CHIP
2007-009201	R6020	R-CHIP
2007-009201	R6021	R-CHIP
2007-009212	R3047	R-CHIP

Confidential and proprietary-the contents in this service guide subject to change without prior notice

Distribution, transmission, or infringement of any content or data from this document without Samsung's written authorization is strictly prohibited.

5. MAIN Electrical Parts List

2007-009212	R5008	R-CHIP
2007-009212	R5018	R-CHIP
2007-009212	R6002	R-CHIP
2007-009212	R9005	R-CHIP
2007-009223	R6001	R-CHIP
2007-009352	R5046	R-CHIP
2007-009354	R7002	R-CHIP
2007-009354	R7003	R-CHIP
2007-009354	R7004	R-CHIP
2007-009408	R10010	R-CHIP
2007-009408	R10013	R-CHIP
2007-009408	R10014	R-CHIP
2007-009408	R3000	R-CHIP
2007-009408	R3001	R-CHIP
2007-009408	R3002	R-CHIP
2007-009408	R3003	R-CHIP
2007-009408	R3004	R-CHIP
2007-009408	R3005	R-CHIP
2007-009408	R3006	R-CHIP
2007-009408	R3007	R-CHIP
2007-009408	R3010	R-CHIP
2007-009408	R3011	R-CHIP
2007-009408	R3014	R-CHIP
2007-009408	R3015	R-CHIP
2007-009408	R3016	R-CHIP
2007-009408	R3017	R-CHIP
2007-009408	R3018	R-CHIP
2007-009408	R3019	R-CHIP
2007-009408	R3020	R-CHIP
2007-009408	R3021	R-CHIP
2007-009408	R3023	R-CHIP
2007-009408	R3025	R-CHIP
2007-009408	R3027	R-CHIP
2007-009408	R3028	R-CHIP
2007-009408	R3029	R-CHIP
2007-009408	R3030	R-CHIP
2007-009408	R3031	R-CHIP
2007-009408	R3032	R-CHIP
2007-009408	R3033	R-CHIP
2007-009408	R3034	R-CHIP

Confidential and proprietary-the contents in this service guide subject to change without prior notice

Distribution, transmission, or infringement of any content or data from this document without Samsung's written authorization is strictly prohibited.

5. MAIN Electrical Parts List

2007-009408	R3057	R-CHIP
2007-009408	R3058	R-CHIP
2007-009408	R5017	R-CHIP
2007-009408	R5021	R-CHIP
2007-009408	R7023	R-CHIP
2007-009410	R1016	R-CHIP
2007-009410	R1021	R-CHIP
2007-009410	R2044	R-CHIP
2007-009410	R2045	R-CHIP
2007-009793	R6004	R-CHIP
2007-009801	R3035	R-CHIP
2007-009801	R3036	R-CHIP
2007-009801	R8007	R-CHIP
2007-009805	R2002	R-CHIP
2007-009805	R2009	R-CHIP
2007-009866	R10023	R-CHIP
2007-009866	R10024	R-CHIP
2007-009866	R10025	R-CHIP
2007-009866	R10026	R-CHIP
2007-009866	R6015	R-CHIP
2007-009920	R3040	R-CHIP
2007-009920	R3041	R-CHIP
2007-009920	R3043	R-CHIP
2007-009920	R3044	R-CHIP
2007-009920	R3045	R-CHIP
2007-009920	R3046	R-CHIP
2007-009969	R6006	R-CHIP
2007-010202	R5038	R-CHIP
2007-010202	R6005	R-CHIP
2007-010202	R7000	R-CHIP
2007-010202	R7001	R-CHIP
2007-010202	R8006	R-CHIP
2007-010685	R1020	R-CHIP
2007-010685	R2003	R-CHIP
2007-010685	R2010	R-CHIP
2007-010856	R5057	R-CHIP
2007-011648	R10003	R-CHIP
2007-011648	R10006	R-CHIP
2007-011648	R5022	R-CHIP
2007-012033	R6000	R-CHIP

Confidential and proprietary-the contents in this service guide subject to change without prior notice

Distribution, transmission, or infringement of any content or data from this document without Samsung's written authorization is strictly prohibited.

5. MAIN Electrical Parts List

2203-000233	C10072	C-CER,CHIP
2203-000233	C10073	C-CER,CHIP
2203-000425	C10006	C-CER,CHIP
2203-000425	C10008	C-CER,CHIP
2203-000425	C10012	C-CER,CHIP
2203-000438	C10059	C-CER,CHIP
2203-000438	C10060	C-CER,CHIP
2203-000438	C6057	C-CER,CHIP
2203-000438	C6070	C-CER,CHIP
2203-000438	C6071	C-CER,CHIP
2203-000438	C6091	C-CER,CHIP
2203-000438	C6092	C-CER,CHIP
2203-000438	U6056	C-CER,CHIP
2203-000812	C8046	C-CER,CHIP
2203-001101	C5103	C-CER,CHIP
2203-001239	C10005	C-CER,CHIP
2203-001239	C10007	C-CER,CHIP
2203-001239	C10011	C-CER,CHIP
2203-001239	C5098	C-CER,CHIP
2203-003019	C5102	C-CER,CHIP
2203-005682	C6060	C-CER,CHIP
2203-005682	C6062	C-CER,CHIP
2203-005682	C7004	C-CER,CHIP
2203-005682	C7005	C-CER,CHIP
2203-005682	C7006	C-CER,CHIP
2203-005719	C2071	C-CER,CHIP
2203-005719	C8063	C-CER,CHIP
2203-005719	C8068	C-CER,CHIP
2203-005725	C2070	C-CER,CHIP
2203-005725	C6050	C-CER,CHIP
2203-005725	C8003	C-CER,CHIP
2203-005725	C8019	C-CER,CHIP
2203-005726	C6068	C-CER,CHIP
2203-005726	C6069	C-CER,CHIP
2203-005729	C2038	C-CER,CHIP
2203-005729	C6020	C-CER,CHIP
2203-005729	C6023	C-CER,CHIP
2203-005731	C6055	C-CER,CHIP
2203-005731	C6056	C-CER,CHIP
2203-005732	C5104	C-CER,CHIP

Confidential and proprietary-the contents in this service guide subject to change without prior notice

Distribution, transmission, or infringement of any content or data from this document without Samsung's written authorization is strictly prohibited.

5. MAIN Electrical Parts List

2203-005732	C6024	C-CER,CHIP
2203-005732	C6053	C-CER,CHIP
2203-005732	C6054	C-CER,CHIP
2203-005732	C8017	C-CER,CHIP
2203-005736	C10032	C-CER,CHIP
2203-005736	C10037	C-CER,CHIP
2203-005736	C10049	C-CER,CHIP
2203-005736	C10064	C-CER,CHIP
2203-005736	C1125	C-CER,CHIP
2203-005736	C1141	C-CER,CHIP
2203-005736	C1142	C-CER,CHIP
2203-005736	C1144	C-CER,CHIP
2203-005736	C1145	C-CER,CHIP
2203-005736	C1216	C-CER,CHIP
2203-005736	C1217	C-CER,CHIP
2203-005736	C2005	C-CER,CHIP
2203-005736	C2020	C-CER,CHIP
2203-005736	C2025	C-CER,CHIP
2203-005736	C2035	C-CER,CHIP
2203-005736	C2036	C-CER,CHIP
2203-005736	C2037	C-CER,CHIP
2203-005736	C2040	C-CER,CHIP
2203-005736	C2042	C-CER,CHIP
2203-005736	C2066	C-CER,CHIP
2203-005736	C2067	C-CER,CHIP
2203-005736	C2069	C-CER,CHIP
2203-005736	C2075	C-CER,CHIP
2203-005736	C7037	C-CER,CHIP
2203-005736	C7045	C-CER,CHIP
2203-005736	C8026	C-CER,CHIP
2203-005736	C8045	C-CER,CHIP
2203-005736	L10017	C-CER,CHIP
2203-005736	L1045	C-CER,CHIP
2203-005736	L1098	C-CER,CHIP
2203-005736	L1152	C-CER,CHIP
2203-005740	C2009	C-CER,CHIP
2203-005740	C2027	C-CER,CHIP
2203-005742	C9009	C-CER,CHIP
2203-005742	C9010	C-CER,CHIP
2203-005777	C10042	C-CER,CHIP

Confidential and proprietary-the contents in this service guide subject to change without prior notice

Distribution, transmission, or infringement of any content or data from this document without Samsung's written authorization is strictly prohibited.

5. MAIN Electrical Parts List

2203-005777	L10020	C-CER,CHIP
2203-005777	L1032	C-CER,CHIP
2203-005777	L9000	C-CER,CHIP
2203-005779	C8000	C-CER,CHIP
2203-005789	C1041	C-CER,CHIP
2203-006048	C2015	C-CER,CHIP
2203-006048	C2031	C-CER,CHIP
2203-006048	C7023	C-CER,CHIP
2203-006048	C8036	C-CER,CHIP
2203-006121	C6022	C-CER,CHIP
2203-006123	C2034	C-CER,CHIP
2203-006123	C2082	C-CER,CHIP
2203-006194	C2045	C-CER,CHIP
2203-006194	C2046	C-CER,CHIP
2203-006194	C2048	C-CER,CHIP
2203-006194	C2050	C-CER,CHIP
2203-006194	C2051	C-CER,CHIP
2203-006194	C2052	C-CER,CHIP
2203-006194	C2059	C-CER,CHIP
2203-006194	C2060	C-CER,CHIP
2203-006194	C2062	C-CER,CHIP
2203-006194	C2063	C-CER,CHIP
2203-006194	C2064	C-CER,CHIP
2203-006194	C2065	C-CER,CHIP
2203-006305	C10017	C-CER,CHIP
2203-006305	C10030	C-CER,CHIP
2203-006305	C10036	C-CER,CHIP
2203-006305	C2018	C-CER,CHIP
2203-006318	C10015	C-CER,CHIP
2203-006379	C6093	C-CER,CHIP
2203-006399	C10024	C-CER,CHIP
2203-006399	C4047	C-CER,CHIP
2203-006399	C5109	C-CER,CHIP
2203-006399	C5150	C-CER,CHIP
2203-006399	C8014	C-CER,CHIP
2203-006399	C8025	C-CER,CHIP
2203-006400	C10003	C-CER,CHIP
2203-006400	C2039	C-CER,CHIP
2203-006400	C4086	C-CER,CHIP
2203-006400	C4087	C-CER,CHIP

Confidential and proprietary-the contents in this service guide subject to change without prior notice

Distribution, transmission, or infringement of any content or data from this document without Samsung's written authorization is strictly prohibited.

5. MAIN Electrical Parts List

2203-006400	C5033	C-CER,CHIP
2203-006400	C6081	C-CER,CHIP
2203-006400	C6082	C-CER,CHIP
2203-006400	C6083	C-CER,CHIP
2203-006400	C7003	C-CER,CHIP
2203-006400	C8042	C-CER,CHIP
2203-006400	C8051	C-CER,CHIP
2203-006400	C8054	C-CER,CHIP
2203-006400	C8055	C-CER,CHIP
2203-006400	C8062	C-CER,CHIP
2203-006400	U10117	C-CER,CHIP
2203-006410	L10019	C-CER,CHIP
2203-006423	C1004	C-CER,CHIP
2203-006423	C1005	C-CER,CHIP
2203-006423	C10050	C-CER,CHIP
2203-006423	C10051	C-CER,CHIP
2203-006423	C10067	C-CER,CHIP
2203-006423	C1012	C-CER,CHIP
2203-006423	C1014	C-CER,CHIP
2203-006423	C1018	C-CER,CHIP
2203-006423	C1019	C-CER,CHIP
2203-006423	C1020	C-CER,CHIP
2203-006423	C1023	C-CER,CHIP
2203-006423	C1034	C-CER,CHIP
2203-006423	C1035	C-CER,CHIP
2203-006423	C1036	C-CER,CHIP
2203-006423	C1037	C-CER,CHIP
2203-006423	C1038	C-CER,CHIP
2203-006423	C1039	C-CER,CHIP
2203-006423	C1049	C-CER,CHIP
2203-006423	C1050	C-CER,CHIP
2203-006423	C1138	C-CER,CHIP
2203-006423	C2019	C-CER,CHIP
2203-006423	C2033	C-CER,CHIP
2203-006423	C4004	C-CER,CHIP
2203-006423	C5118	C-CER,CHIP
2203-006423	C5119	C-CER,CHIP
2203-006423	C5132	C-CER,CHIP
2203-006423	C6008	C-CER,CHIP
2203-006423	C6009	C-CER,CHIP

Confidential and proprietary-the contents in this service guide subject to change without prior notice

Distribution, transmission, or infringement of any content or data from this document without Samsung's written authorization is strictly prohibited.

5. MAIN Electrical Parts List

2203-006423	C6010	C-CER,CHIP
2203-006423	C6011	C-CER,CHIP
2203-006423	C6012	C-CER,CHIP
2203-006423	C6015	C-CER,CHIP
2203-006423	C6016	C-CER,CHIP
2203-006423	C6017	C-CER,CHIP
2203-006423	C6021	C-CER,CHIP
2203-006423	C6027	C-CER,CHIP
2203-006423	C6028	C-CER,CHIP
2203-006423	C6031	C-CER,CHIP
2203-006423	C6032	C-CER,CHIP
2203-006423	C6034	C-CER,CHIP
2203-006423	C6037	C-CER,CHIP
2203-006423	C6045	C-CER,CHIP
2203-006423	C7001	C-CER,CHIP
2203-006423	C7002	C-CER,CHIP
2203-006423	C7010	C-CER,CHIP
2203-006423	C7011	C-CER,CHIP
2203-006423	C7012	C-CER,CHIP
2203-006423	C7013	C-CER,CHIP
2203-006423	C7014	C-CER,CHIP
2203-006423	C7015	C-CER,CHIP
2203-006423	C7016	C-CER,CHIP
2203-006423	C7017	C-CER,CHIP
2203-006423	C7020	C-CER,CHIP
2203-006423	C7025	C-CER,CHIP
2203-006423	C7026	C-CER,CHIP
2203-006423	C7032	C-CER,CHIP
2203-006423	C7033	C-CER,CHIP
2203-006423	C8016	C-CER,CHIP
2203-006423	C8059	C-CER,CHIP
2203-006423	C9016	C-CER,CHIP
2203-006556	C8006	C-CER,CHIP
2203-006562	C10071	C-CER,CHIP
2203-006562	C2014	C-CER,CHIP
2203-006562	C2030	C-CER,CHIP
2203-006562	C5085	C-CER,CHIP
2203-006562	C5086	C-CER,CHIP
2203-006562	C6107	C-CER,CHIP
2203-006562	C6108	C-CER,CHIP

Confidential and proprietary-the contents in this service guide subject to change without prior notice

Distribution, transmission, or infringement of any content or data from this document without Samsung's written authorization is strictly prohibited.

5. MAIN Electrical Parts List

2203-006562	C6109	C-CER,CHIP
2203-006562	C8024	C-CER,CHIP
2203-006562	C8029	C-CER,CHIP
2203-006562	C8031	C-CER,CHIP
2203-006562	C8035	C-CER,CHIP
2203-006604	C7030	C-CER,CHIP
2203-006611	L2013	C-CER,CHIP
2203-006611	L2043	C-CER,CHIP
2203-006642	C8001	C-CER,CHIP
2203-006647	C10074	C-CER,CHIP
2203-006648	C7038	C-CER,CHIP
2203-006648	C7046	C-CER,CHIP
2203-006665	C7031	C-CER,CHIP
2203-006665	L2055	C-CER,CHIP
2203-006674	L10018	C-CER,CHIP
2203-006707	C1073	C-CER,CHIP
2203-006839	C10065	C-CER,CHIP
2203-006839	C5077	C-CER,CHIP
2203-006839	C6000	C-CER,CHIP
2203-006839	C6005	C-CER,CHIP
2203-006839	C6006	C-CER,CHIP
2203-006839	C6096	C-CER,CHIP
2203-006839	C6097	C-CER,CHIP
2203-006839	C6098	C-CER,CHIP
2203-006844	C10046	C-CER,CHIP
2203-006844	C10048	C-CER,CHIP
2203-006844	C10052	C-CER,CHIP
2203-006844	C10054	C-CER,CHIP
2203-006846	C2080	C-CER,CHIP
2203-006846	C2081	C-CER,CHIP
2203-006872	C8044	C-CER,CHIP
2203-006872	C8047	C-CER,CHIP
2203-006872	C8052	C-CER,CHIP
2203-006978	C4100	C-CER,CHIP
2203-006978	C5143	C-CER,CHIP
2203-006978	C5144	C-CER,CHIP
2203-007143	C5124	C-CER,CHIP
2203-007194	C6040	C-CER,CHIP
2203-007194	C6041	C-CER,CHIP
2203-007210	C1003	C-CER,CHIP

Confidential and proprietary-the contents in this service guide subject to change without prior notice

Distribution, transmission, or infringement of any content or data from this document without Samsung's written authorization is strictly prohibited.

5. MAIN Electrical Parts List

2203-007210	C1013	C-CER,CHIP
2203-007210	C1016	C-CER,CHIP
2203-007210	C1017	C-CER,CHIP
2203-007210	C1022	C-CER,CHIP
2203-007210	C1024	C-CER,CHIP
2203-007210	C1033	C-CER,CHIP
2203-007210	C1044	C-CER,CHIP
2203-007210	C2061	C-CER,CHIP
2203-007210	C4014	C-CER,CHIP
2203-007210	C4024	C-CER,CHIP
2203-007210	C4071	C-CER,CHIP
2203-007210	C4072	C-CER,CHIP
2203-007210	C4080	C-CER,CHIP
2203-007210	C4098	C-CER,CHIP
2203-007210	C4101	C-CER,CHIP
2203-007210	U4006	C-CER,CHIP
2203-007240	C8048	C-CER,CHIP
2203-007240	C8049	C-CER,CHIP
2203-007269	C8033	C-CER,CHIP
2203-007269	C8034	C-CER,CHIP
2203-007269	C8037	C-CER,CHIP
2203-007269	C8038	C-CER,CHIP
2203-007269	C8039	C-CER,CHIP
2203-007269	C8040	C-CER,CHIP
2203-007271	C2058	C-CER,CHIP
2203-007271	C9004	C-CER,CHIP
2203-007271	C9005	C-CER,CHIP
2203-007279	C10000	C-CER,CHIP
2203-007279	C10002	C-CER,CHIP
2203-007279	C10009	C-CER,CHIP
2203-007279	C6064	C-CER,CHIP
2203-007279	C6067	C-CER,CHIP
2203-007279	C6072	C-CER,CHIP
2203-007279	C6073	C-CER,CHIP
2203-007279	C6075	C-CER,CHIP
2203-007279	C6076	C-CER,CHIP
2203-007279	C6078	C-CER,CHIP
2203-007279	C6080	C-CER,CHIP
2203-007279	C6099	C-CER,CHIP
2203-007279	C8069	C-CER,CHIP

Confidential and proprietary-the contents in this service guide subject to change without prior notice

Distribution, transmission, or infringement of any content or data from this document without Samsung's written authorization is strictly prohibited.

5. MAIN Electrical Parts List

2203-007279	C8070	C-CER,CHIP
2203-007317	C1011	C-CER,CHIP
2203-007317	C1015	C-CER,CHIP
2203-007317	C1021	C-CER,CHIP
2203-007317	C2044	C-CER,CHIP
2203-007317	C2049	C-CER,CHIP
2203-007317	C2053	C-CER,CHIP
2203-007317	C4076	C-CER,CHIP
2203-007317	C5043	C-CER,CHIP
2203-007317	C5044	C-CER,CHIP
2203-007317	C5046	C-CER,CHIP
2203-007317	C5067	C-CER,CHIP
2203-007317	C5069	C-CER,CHIP
2203-007317	C6035	C-CER,CHIP
2203-007317	C6036	C-CER,CHIP
2203-007317	C7041	C-CER,CHIP
2203-007317	C8008	C-CER,CHIP
2203-007317	C8009	C-CER,CHIP
2203-007391	C2054	C-CER,CHIP
2203-007391	C2056	C-CER,CHIP
2203-007391	C2057	C-CER,CHIP
2203-007391	C6003	C-CER,CHIP
2203-007391	C6014	C-CER,CHIP
2203-007391	C6030	C-CER,CHIP
2203-007391	C6043	C-CER,CHIP
2203-007391	C6044	C-CER,CHIP
2203-007391	C9008	C-CER,CHIP
2203-007392	C5006	C-CER,CHIP
2203-007392	C5032	C-CER,CHIP
2203-007392	C5036	C-CER,CHIP
2203-007392	C5101	C-CER,CHIP
2203-007392	C5114	C-CER,CHIP
2203-007392	C5136	C-CER,CHIP
2203-007392	C8053	C-CER,CHIP
2203-007393	C5082	C-CER,CHIP
2203-007393	C5083	C-CER,CHIP
2203-007393	C5115	C-CER,CHIP
2203-007393	C6007	C-CER,CHIP
2203-007393	C6039	C-CER,CHIP
2203-007393	C7034	C-CER,CHIP

Confidential and proprietary-the contents in this service guide subject to change without prior notice

Distribution, transmission, or infringement of any content or data from this document without Samsung's written authorization is strictly prohibited.

5. MAIN Electrical Parts List

2203-007393	C7039	C-CER,CHIP
2203-007393	C8027	C-CER,CHIP
2203-007393	C9019	C-CER,CHIP
2203-007456	C5030	C-CER,CHIP
2203-007456	C5031	C-CER,CHIP
2203-007456	C5116	C-CER,CHIP
2203-007456	C5134	C-CER,CHIP
2203-007456	C5135	C-CER,CHIP
2203-007456	C5137	C-CER,CHIP
2203-007456	C5146	C-CER,CHIP
2203-007456	C5148	C-CER,CHIP
2203-007486	C5117	C-CER,CHIP
2203-007781	C10004	C-CER,CHIP
2203-007781	C5087	C-CER,CHIP
2203-007781	C5099	C-CER,CHIP
2203-007781	C5100	C-CER,CHIP
2203-007781	C6086	C-CER,CHIP
2203-007781	C6087	C-CER,CHIP
2203-007781	C6088	C-CER,CHIP
2203-007796	C4000	C-CER,CHIP
2203-007796	C4001	C-CER,CHIP
2203-007796	C4007	C-CER,CHIP
2203-007796	C4008	C-CER,CHIP
2203-007796	C4009	C-CER,CHIP
2203-007796	C4010	C-CER,CHIP
2203-007796	C4011	C-CER,CHIP
2203-007796	C4020	C-CER,CHIP
2203-007796	C4021	C-CER,CHIP
2203-007796	C4022	C-CER,CHIP
2203-007796	C4023	C-CER,CHIP
2203-007796	C4028	C-CER,CHIP
2203-007796	C4035	C-CER,CHIP
2203-007796	C4036	C-CER,CHIP
2203-007796	C4037	C-CER,CHIP
2203-007796	C4038	C-CER,CHIP
2203-007796	C4039	C-CER,CHIP
2203-007796	C4040	C-CER,CHIP
2203-007796	C4042	C-CER,CHIP
2203-007796	C4043	C-CER,CHIP
2203-007796	C4048	C-CER,CHIP

Confidential and proprietary-the contents in this service guide subject to change without prior notice

Distribution, transmission, or infringement of any content or data from this document without Samsung's written authorization is strictly prohibited.

5. MAIN Electrical Parts List

2203-007796	C4049	C-CER,CHIP
2203-007796	C4050	C-CER,CHIP
2203-007796	C4051	C-CER,CHIP
2203-007796	C4053	C-CER,CHIP
2203-007796	C4055	C-CER,CHIP
2203-007796	C4056	C-CER,CHIP
2203-007796	C4057	C-CER,CHIP
2203-007796	C4058	C-CER,CHIP
2203-007796	C4066	C-CER,CHIP
2203-007796	C4067	C-CER,CHIP
2203-007796	C4068	C-CER,CHIP
2203-007796	C4073	C-CER,CHIP
2203-007796	C4074	C-CER,CHIP
2203-007796	C4075	C-CER,CHIP
2203-007796	C4092	C-CER,CHIP
2203-007796	C4093	C-CER,CHIP
2203-007796	C4094	C-CER,CHIP
2203-007796	C4099	C-CER,CHIP
2203-007796	C5056	C-CER,CHIP
2203-007796	C5064	C-CER,CHIP
2203-007796	C5068	C-CER,CHIP
2203-007796	C5074	C-CER,CHIP
2203-007796	C5081	C-CER,CHIP
2203-007796	C6004	C-CER,CHIP
2203-007796	C6019	C-CER,CHIP
2203-007796	C6038	C-CER,CHIP
2203-007796	C7008	C-CER,CHIP
2203-007796	C7027	C-CER,CHIP
2203-007796	C8030	C-CER,CHIP
2203-007796	C8032	C-CER,CHIP
2203-008097	C10025	C-CER,CHIP
2203-008097	C10045	C-CER,CHIP
2203-008097	C10047	C-CER,CHIP
2203-008097	C10053	C-CER,CHIP
2203-008097	C10055	C-CER,CHIP
2203-008097	C3001	C-CER,CHIP
2203-008097	C3002	C-CER,CHIP
2203-008097	C4069	C-CER,CHIP
2203-008097	C4070	C-CER,CHIP
2203-008097	C4081	C-CER,CHIP

Confidential and proprietary-the contents in this service guide subject to change without prior notice

Distribution, transmission, or infringement of any content or data from this document without Samsung's written authorization is strictly prohibited.

5. MAIN Electrical Parts List

2203-008097	C5020	C-CER,CHIP
2203-008097	C5028	C-CER,CHIP
2203-008097	C6059	C-CER,CHIP
2203-008097	C6061	C-CER,CHIP
2203-008158	C5049	C-CER,CHIP
2203-008158	C5075	C-CER,CHIP
2203-008158	C5138	C-CER,CHIP
2203-008242	C4002	C-CER,CHIP
2203-008242	C4003	C-CER,CHIP
2203-008242	C4085	C-CER,CHIP
2203-008242	C5053	C-CER,CHIP
2203-008242	C5054	C-CER,CHIP
2203-008242	C5055	C-CER,CHIP
2203-008242	C5065	C-CER,CHIP
2203-008242	C5072	C-CER,CHIP
2203-008242	C5073	C-CER,CHIP
2203-008242	C8005	C-CER,CHIP
2203-008243	C5125	C-CER,CHIP
2203-008243	C5131	C-CER,CHIP
2203-008243	C5133	C-CER,CHIP
2203-008243	C5145	C-CER,CHIP
2203-008243	C5147	C-CER,CHIP
2203-008243	C8007	C-CER,CHIP
2203-008394	C10029	C-CER,CHIP
2203-008529	C2010	C-CER,CHIP
2203-008529	C2028	C-CER,CHIP
2203-008529	C5038	C-CER,CHIP
2203-008529	C5041	C-CER,CHIP
2203-008529	C5042	C-CER,CHIP
2203-008529	C5078	C-CER,CHIP
2203-008529	C5097	C-CER,CHIP
2203-008529	C5140	C-CER,CHIP
2203-008529	C6051	C-CER,CHIP
2203-008529	C8020	C-CER,CHIP
2203-008529	C8021	C-CER,CHIP
2203-008529	C8023	C-CER,CHIP
2203-008572	C5037	C-CER,CHIP
2203-008572	C5051	C-CER,CHIP
2203-008572	C5052	C-CER,CHIP
2203-008572	C5139	C-CER,CHIP

Confidential and proprietary-the contents in this service guide subject to change without prior notice

Distribution, transmission, or infringement of any content or data from this document without Samsung's written authorization is strictly prohibited.

5. MAIN Electrical Parts List

2203-008572	C5151	C-CER,CHIP
2203-008860	C10022	C-CER,CHIP
2203-008860	C10023	C-CER,CHIP
2203-008860	C4025	C-CER,CHIP
2203-008860	C4026	C-CER,CHIP
2203-008860	C4041	C-CER,CHIP
2203-008860	C4084	C-CER,CHIP
2203-008860	C4095	C-CER,CHIP
2203-008860	C5016	C-CER,CHIP
2203-008860	C5026	C-CER,CHIP
2203-008860	C5079	C-CER,CHIP
2203-008860	C5080	C-CER,CHIP
2203-008860	C5095	C-CER,CHIP
2203-008860	C5108	C-CER,CHIP
2203-008860	C5149	C-CER,CHIP
2203-008860	C6001	C-CER,CHIP
2203-008860	C6002	C-CER,CHIP
2203-008860	C6013	C-CER,CHIP
2203-008860	C6018	C-CER,CHIP
2203-008860	C6026	C-CER,CHIP
2203-008860	C6029	C-CER,CHIP
2203-008860	C6033	C-CER,CHIP
2203-008860	C6048	C-CER,CHIP
2203-008860	C6094	C-CER,CHIP
2203-008860	C6095	C-CER,CHIP
2203-008860	C7007	C-CER,CHIP
2203-008860	C7028	C-CER,CHIP
2203-008860	C7051	C-CER,CHIP
2203-008860	C7052	C-CER,CHIP
2203-008860	C8043	C-CER,CHIP
2203-008860	C9006	C-CER,CHIP
2203-008860	C9007	C-CER,CHIP
2203-008860	C9012	C-CER,CHIP
2203-008860	C9013	C-CER,CHIP
2203-008860	C9014	C-CER,CHIP
2203-008860	C9015	C-CER,CHIP
2203-008860	C9018	C-CER,CHIP
2203-008876	C4052	C-CER,CHIP
2203-008876	C4054	C-CER,CHIP
2203-008876	C4077	C-CER,CHIP

Confidential and proprietary-the contents in this service guide subject to change without prior notice

Distribution, transmission, or infringement of any content or data from this document without Samsung's written authorization is strictly prohibited.

5. MAIN Electrical Parts List

2203-008876	C5004	C-CER,CHIP
2203-008876	C5007	C-CER,CHIP
2203-008876	C5010	C-CER,CHIP
2203-008876	C5011	C-CER,CHIP
2203-008876	C5012	C-CER,CHIP
2203-008876	C5013	C-CER,CHIP
2203-008876	C5014	C-CER,CHIP
2203-008876	C5015	C-CER,CHIP
2203-008876	C5017	C-CER,CHIP
2203-008876	C5018	C-CER,CHIP
2203-008876	C5019	C-CER,CHIP
2203-008876	C5021	C-CER,CHIP
2203-008876	C5022	C-CER,CHIP
2203-008876	C5023	C-CER,CHIP
2203-008876	C5024	C-CER,CHIP
2203-008876	C5025	C-CER,CHIP
2203-008876	C5057	C-CER,CHIP
2203-008876	C5058	C-CER,CHIP
2203-008876	C5060	C-CER,CHIP
2203-008876	C5061	C-CER,CHIP
2203-008876	C5062	C-CER,CHIP
2203-008876	C5063	C-CER,CHIP
2203-008876	C5066	C-CER,CHIP
2203-008876	C5070	C-CER,CHIP
2203-008876	C8004	C-CER,CHIP
2203-008876	C8022	C-CER,CHIP
2203-008876	C8028	C-CER,CHIP
2203-008876	C8058	C-CER,CHIP
2203-008876	C8066	C-CER,CHIP
2203-008876	C8067	C-CER,CHIP
2203-008886	C6049	C-CER,CHIP
2203-009064	C4016	C-CER,CHIP
2203-009064	C4017	C-CER,CHIP
2203-009064	C4018	C-CER,CHIP
2203-009064	C4019	C-CER,CHIP
2203-009064	C4032	C-CER,CHIP
2203-009064	C4033	C-CER,CHIP
2203-009064	C4034	C-CER,CHIP
2203-009064	C4063	C-CER,CHIP
2203-009223	C10035	C-CER,CHIP

Confidential and proprietary-the contents in this service guide subject to change without prior notice

Distribution, transmission, or infringement of any content or data from this document without Samsung's written authorization is strictly prohibited.

5. MAIN Electrical Parts List

2203-009223	C10040	C-CER,CHIP
2203-009223	C1079	C-CER,CHIP
2203-009223	C1100	C-CER,CHIP
2203-009223	C7022	C-CER,CHIP
2203-009223	C7024	C-CER,CHIP
2203-009223	C9001	C-CER,CHIP
2203-009223	C9002	C-CER,CHIP
2203-009328	C2068	C-CER,CHIP
2203-009328	C5088	C-CER,CHIP
2203-009328	C5090	C-CER,CHIP
2203-009328	C5091	C-CER,CHIP
2203-009328	C5094	C-CER,CHIP
2203-009444	C5034	C-CER,CHIP
2203-009537	C4012	C-CER,CHIP
2203-009537	C4013	C-CER,CHIP
2203-009537	C4062	C-CER,CHIP
2203-009618	C5035	C-CER,CHIP
2203-009618	C5096	C-CER,CHIP
2203-009618	C5141	C-CER,CHIP
2203-009732	C5089	C-CER,CHIP
2203-009732	C5092	C-CER,CHIP
2203-009732	C5093	C-CER,CHIP
2203-009733	C2043	C-CER,CHIP
2203-009733	C2047	C-CER,CHIP
2203-009733	C2055	C-CER,CHIP
2203-009733	C4078	C-CER,CHIP
2203-009733	C4079	C-CER,CHIP
2203-009733	C6052	C-CER,CHIP
2203-009733	C8015	C-CER,CHIP
2203-009733	C8018	C-CER,CHIP
2203-009734	C5122	C-CER,CHIP
2203-009734	C5123	C-CER,CHIP
2203-009735	C4027	C-CER,CHIP
2203-009735	C4029	C-CER,CHIP
2203-009735	C4030	C-CER,CHIP
2203-009735	C4031	C-CER,CHIP
2203-009735	C4059	C-CER,CHIP
2203-009735	C4060	C-CER,CHIP
2203-009735	C4061	C-CER,CHIP
2203-009736	C4091	C-CER,CHIP

Confidential and proprietary-the contents in this service guide subject to change without prior notice

Distribution, transmission, or infringement of any content or data from this document without Samsung's written authorization is strictly prohibited.

5. MAIN Electrical Parts List

2203-009736	C5045	C-CER,CHIP
2203-009736	C5047	C-CER,CHIP
2203-009736	C5048	C-CER,CHIP
2203-009736	C5071	C-CER,CHIP
2203-009742	C4005	C-CER,CHIP
2203-009742	C4006	C-CER,CHIP
2203-009858	C5050	C-CER,CHIP
2203-009858	C5113	C-CER,CHIP
2203-009858	C5142	C-CER,CHIP
2203-009859	C5000	C-CER,CHIP
2203-009859	C5001	C-CER,CHIP
2203-009859	C5002	C-CER,CHIP
2203-009859	C5003	C-CER,CHIP
2203-009859	C5005	C-CER,CHIP
2203-009859	C5008	C-CER,CHIP
2203-009859	C5009	C-CER,CHIP
2203-009859	C5029	C-CER,CHIP
2203-009859	C5039	C-CER,CHIP
2203-009859	C5040	C-CER,CHIP
2203-009859	C5084	C-CER,CHIP
2203-009859	C5120	C-CER,CHIP
2203-009859	C5121	C-CER,CHIP
2703-001728	L10016	INDUCTOR-SMD
2703-002649	L2036	INDUCTOR-SMD
2703-002649	L2047	INDUCTOR-SMD
2703-002900	L7010	INDUCTOR-SMD
2703-002903	L10011	INDUCTOR-SMD
2703-002903	L2052	INDUCTOR-SMD
2703-002903	L7016	INDUCTOR-SMD
2703-002955	L2058	INDUCTOR-SMD
2703-002958	L10027	INDUCTOR-SMD
2703-002958	L10028	INDUCTOR-SMD
2703-002958	L1031	INDUCTOR-SMD
2703-002958	L1101	INDUCTOR-SMD
2703-002958	L1145	INDUCTOR-SMD
2703-002958	L1146	INDUCTOR-SMD
2703-002958	L2007	INDUCTOR-SMD
2703-002958	L2033	INDUCTOR-SMD
2703-002959	L8002	INDUCTOR-SMD
2703-002959	L8003	INDUCTOR-SMD

Confidential and proprietary-the contents in this service guide subject to change without prior notice

Distribution, transmission, or infringement of any content or data from this document without Samsung's written authorization is strictly prohibited.

5. MAIN Electrical Parts List

2703-002961	L10006	INDUCTOR-SMD
2703-002961	L10021	INDUCTOR-SMD
2703-002961	L2010	INDUCTOR-SMD
2703-002961	L8006	INDUCTOR-SMD
2703-002999	C10038	INDUCTOR-SMD
2703-003004	L1092	INDUCTOR-SMD
2703-004000	L2049	INDUCTOR-SMD
2703-004013	C2017	INDUCTOR-SMD
2703-004013	L2012	INDUCTOR-SMD
2703-004018	C9003	INDUCTOR-SMD
2703-004018	L2003	INDUCTOR-SMD
2703-004018	L9001	INDUCTOR-SMD
2703-004034	C2041	INDUCTOR-SMD
2703-004034	C2079	INDUCTOR-SMD
2703-004034	L2002	INDUCTOR-SMD
2703-004034	L2031	INDUCTOR-SMD
2703-004034	L2042	INDUCTOR-SMD
2703-004034	L2051	INDUCTOR-SMD
2703-004034	L2057	INDUCTOR-SMD
2703-004286	L2044	INDUCTOR-SMD
2703-004287	C2083	INDUCTOR-SMD
2703-004287	C9000	INDUCTOR-SMD
2703-004287	L2018	INDUCTOR-SMD
2703-004289	C1124	INDUCTOR-SMD
2703-004289	C1150	INDUCTOR-SMD
2703-004300	C2001	INDUCTOR-SMD
2703-004300	C2004	INDUCTOR-SMD
2703-004300	L2011	INDUCTOR-SMD
2703-004300	L2035	INDUCTOR-SMD
2703-004300	L2040	INDUCTOR-SMD
2703-004301	C2021	INDUCTOR-SMD
2703-004301	C2024	INDUCTOR-SMD
2703-004301	C2032	INDUCTOR-SMD
2703-004301	L2005	INDUCTOR-SMD
2703-004301	L2029	INDUCTOR-SMD
2703-004301	L2048	INDUCTOR-SMD
2703-004317	C2073	INDUCTOR-SMD
2703-004317	C2084	INDUCTOR-SMD
2703-004317	L2000	INDUCTOR-SMD
2703-004328	L2015	INDUCTOR-SMD

Confidential and proprietary-the contents in this service guide subject to change without prior notice

Distribution, transmission, or infringement of any content or data from this document without Samsung's written authorization is strictly prohibited.

5. MAIN Electrical Parts List

2703-004328	L2045	INDUCTOR-SMD
2703-004703	L7000	INDUCTOR-SMD
2703-004703	L7001	INDUCTOR-SMD
2703-004703	L7002	INDUCTOR-SMD
2703-004853	L10012	INDUCTOR-SMD
2703-004853	L1063	INDUCTOR-SMD
2703-004853	L1094	INDUCTOR-SMD
2703-004853	L2039	INDUCTOR-SMD
2703-004947	L10000	INDUCTOR-SMD
2703-004947	L6010	INDUCTOR-SMD
2703-004947	L6011	INDUCTOR-SMD
2703-004947	L6012	INDUCTOR-SMD
2703-004947	L8011	INDUCTOR-SMD
2703-005109	L5025	INDUCTOR-SMD
2703-005136	L5002	INDUCTOR-SMD
2703-005136	L5010	INDUCTOR-SMD
2703-005200	L6007	INDUCTOR-SMD
2703-005201	L5004	INDUCTOR-SMD
2703-005201	L5007	INDUCTOR-SMD
2703-005201	L5018	INDUCTOR-SMD
2703-005233	L6008	INDUCTOR-SMD
2703-005233	L6009	INDUCTOR-SMD
2703-005313	L8008	INDUCTOR-SMD
2703-005313	L8010	INDUCTOR-SMD
2703-005505	L5013	INDUCTOR-SMD
2703-005505	L5014	INDUCTOR-SMD
2703-005505	L8004	INDUCTOR-SMD
2703-005505	L8005	INDUCTOR-SMD
2703-005509	L5005	INDUCTOR-SMD
2703-005509	L5006	INDUCTOR-SMD
2703-005509	L5011	INDUCTOR-SMD
2703-005509	L5012	INDUCTOR-SMD
2703-005509	L5015	INDUCTOR-SMD
2703-005509	L5016	INDUCTOR-SMD
2703-005509	L5017	INDUCTOR-SMD
2703-005509	L5019	INDUCTOR-SMD
2703-005509	L5020	INDUCTOR-SMD
2703-005509	L5021	INDUCTOR-SMD
2703-005509	L5022	INDUCTOR-SMD
2703-005509	L5023	INDUCTOR-SMD

Confidential and proprietary-the contents in this service guide subject to change without prior notice

Distribution, transmission, or infringement of any content or data from this document without Samsung's written authorization is strictly prohibited.

5. MAIN Electrical Parts List

2703-005509	U5006	INDUCTOR-SMD
2801-005444	OSC9000	CRYSTAL-SMD
2801-005481	OSC5000	CRYSTAL-SMD
2901-001690	C4015	FILTER-EMI SMD
2901-001690	C4064	FILTER-EMI SMD
2901-001690	C4065	FILTER-EMI SMD
2901-001690	C4088	FILTER-EMI SMD
2901-001690	C4089	FILTER-EMI SMD
2901-001690	C4090	FILTER-EMI SMD
2903-001576	F2000	FILTER-CERAMIC
2903-001576	F2003	FILTER-CERAMIC
2904-002356	F1005	FILTER SAW GPS
2904-002356	F2007	FILTER SAW GPS
2904-002360	F2002	FILTER SAW WIFI
2904-002360	F2005	FILTER SAW WIFI
2911-000463	U2003	DUPLEXER FEM WIFI
2911-000463	U2006	DUPLEXER FEM WIFI
3301-001534	L6000	BEAD-SMD
3301-001534	L6002	BEAD-SMD
3301-001789	L8014	BEAD-SMD
3301-001869	L6019	BEAD-SMD
3301-001885	L6003	BEAD-SMD
3301-001885	L6004	BEAD-SMD
3301-001901	L10015	BEAD-SMD
3301-002065	L10001	BEAD-SMD
3301-002078	L10029	BEAD-SMD
3301-002078	L7006	BEAD-SMD
3301-002085	L9002	BEAD-SMD
3301-002085	L9003	BEAD-SMD
3301-002122	L10024	BEAD-SMD
3301-002122	L10026	BEAD-SMD
3301-002122	L6013	BEAD-SMD
3301-002122	L6014	BEAD-SMD
3301-002122	L6015	BEAD-SMD
3301-002122	L6016	BEAD-SMD
3301-002122	L6017	BEAD-SMD
3301-002122	L6018	BEAD-SMD
3301-002223	L8000	BEAD-SMD
3301-002223	L8001	BEAD-SMD
3301-002223	L8013	BEAD-SMD

Confidential and proprietary-the contents in this service guide subject to change without prior notice

Distribution, transmission, or infringement of any content or data from this document without Samsung's written authorization is strictly prohibited.

5. MAIN Electrical Parts List

3301-002235	L10030	BEAD-SMD
3301-002235	L10031	BEAD-SMD
3301-002235	L7008	BEAD-SMD
3301-002235	L7009	BEAD-SMD
3301-002237	L1003	BEAD-SMD
3301-002237	L1005	BEAD-SMD
3301-002237	L2046	BEAD-SMD
3301-002237	L6001	BEAD-SMD
3301-002244	L8007	BEAD-SMD
3301-002244	L8009	BEAD-SMD
3301-002244	L8012	BEAD-SMD
3301-002279	L7012	BEAD-SMD
3301-002287	L7003	BEAD-SMD
3301-002331	L5001	BEAD-SMD
3301-002331	L5008	BEAD-SMD
3301-002331	L5009	BEAD-SMD
3301-002331	L5024	BEAD-SMD
3301-002356	L6005	BEAD-SMD
3301-002356	L6006	BEAD-SMD
3301-002356	U6007	BEAD-SMD
3705-001937	RFS10000	CONNECTOR-COAXIAL
3705-001937	RFS10001	CONNECTOR-COAXIAL
3705-001937	RFS10002	CONNECTOR-COAXIAL
3705-001937	RFS1003	CONNECTOR-COAXIAL
3705-001937	RFS2001	CONNECTOR-COAXIAL
3705-001937	RFS2002	CONNECTOR-COAXIAL
3705-001937	RFS9000	CONNECTOR-COAXIAL
3711-007107	HEA8000	SOCKET-BOARD TO BOARD
3711-007295	HDC8001	HEADER-BOARD TO BOARD
3711-007810	HDC7001	HEADER-BOARD TO BOARD
3711-008161	HDC7000	HEADER-BOARD TO BOARD
3711-008741	HDC8000	HEADER-BOARD TO BOARD
3711-008847	BTC5000	CONNECTOR-BATTERY
3711-008847	HDC5000	CONNECTOR-BATTERY
3711-008997	HDC10000	HEADER-BOARD TO BOARD
3711-008997	HDC10001	HEADER-BOARD TO BOARD
3711-008997	HDC6001	HEADER-BOARD TO BOARD
3711-008997	HDC8003	HEADER-BOARD TO BOARD
3711-008997	HDC9002	HEADER-BOARD TO BOARD
3711-009302	HDC10002	HEADER-BOARD TO BOARD

Confidential and proprietary-the contents in this service guide subject to change without prior notice

Distribution, transmission, or infringement of any content or data from this document without Samsung's written authorization is strictly prohibited.

5. MAIN Electrical Parts List

3711-009302	HDC7002	HEADER-BOARD TO BOARD
3711-009302	HDC8004	HEADER-BOARD TO BOARD
3711-009302	HDC9001	HEADER-BOARD TO BOARD
3712-001604	ANT1001	CONNECTOR-TERMINAL
3712-001604	ANT1003	CONNECTOR-TERMINAL
3712-001604	ANT1004	CONNECTOR-TERMINAL
3712-001604	ANT6000	CONNECTOR-TERMINAL
3712-001604	ANT6001	CONNECTOR-TERMINAL
3712-001604	ANT6002	CONNECTOR-TERMINAL
3712-001604	ANT6003	CONNECTOR-TERMINAL
3712-001604	ANT6004	CONNECTOR-TERMINAL
3712-001604	ANT6005	CONNECTOR-TERMINAL
3712-001604	ANT6006	CONNECTOR-TERMINAL
3712-001604	ANT6007	CONNECTOR-TERMINAL
3712-001604	ANT6008	CONNECTOR-TERMINAL
3712-001604	ANT6009	CONNECTOR-TERMINAL
3712-001604	ANT6010	CONNECTOR-TERMINAL
3712-001604	ANT6011	CONNECTOR-TERMINAL
3712-001604	ANT6012	CONNECTOR-TERMINAL
3712-001604	ANT6013	CONNECTOR-TERMINAL
3712-001604	ANT9000	CONNECTOR-TERMINAL
3712-001604	ANT9001	CONNECTOR-TERMINAL
3712-001633	ANT10002	CONNECTOR-TERMINAL
3712-001633	ANT10004	CONNECTOR-TERMINAL
3712-001633	ANT10006	CONNECTOR-TERMINAL
3712-001633	ANT10007	CONNECTOR-TERMINAL
3712-001633	ANT10009	CONNECTOR-TERMINAL
3712-001633	ANT10010	CONNECTOR-TERMINAL
3712-001666	ANT7000	CONNECTOR-TERMINAL
3712-001666	ANT7001	CONNECTOR-TERMINAL
3712-001666	ANT7002	CONNECTOR-TERMINAL
3712-001666	ANT7003	CONNECTOR-TERMINAL
3722-004059	USB10000	JACK-USB
4709-002150	F2001	COUPLER-DIRECTION
4709-002150	F2004	COUPLER-DIRECTION
4709-002285	DIF2000	FREQ-DISTRIBUTER
4709-002285	DIF2001	FREQ-DISTRIBUTER
GH41-05424A	-	PCB MAIN-SM-T835
GH60-00010A	U10043	CLIP-SM_G930F
GH60-00010A	U9006	CLIP-SM_G930F

Confidential and proprietary-the contents in this service guide subject to change without prior notice

Distribution, transmission, or infringement of any content or data from this document without Samsung's written authorization is strictly prohibited.

5. MAIN Electrical Parts List

GH62-00042A	CN8000	PAD GAP-SMD GASKET
GH63-10226A	SC2000	SHIELD-COVER DCDC
GH63-10570D	SC10001	SHIELD-CAN_COVER_D
GH63-10570D	SC2002	SHIELD-CAN_COVER_D
GH63-10570D	SC2015	SHIELD-CAN_COVER_D
GH63-14267A	SC10000	SHIELD-CAN NFC KOR
GH63-15595A	SC2008	SHIELD-MAIN BOT IF PM
GH63-15596A	SC2005	SHIELD-MAIN BOT OCTA DCDC
GH63-15628A	SC2009	SHIELD-MAIN BOT RF1
GH63-15708A	SC2007	SHIELD-MAIN TOP RF2
GH98-42850A	SC2011	ASSY SHIELD CAN-MAIN BOT AP

Please consult the GSPN website (Samsung Portal) for the most recent version of the product's part list.

6. Level 1 Repair

6-1. S/W Update

6-1-1. Preparation

- S/W Update program : [Fenrir 5.17.xxxx](#)
- Mobile Phone
- Data Cable

※ Settings



Data Link Cable



Data Cable : [GH39-01886A](#)

6. Level 1 Repair

6-1-2. How to use 'Fenrir' S/W update program.

1) Launch Fenrir by clicking on the icon on the desktop

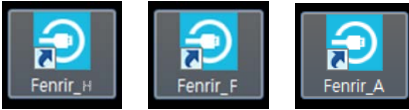

- SVH (Fenrir_Home) : It uses Home binary which does not have user data area in the memory when flashed to a device. (Keep user data)

- SVC (Fenrir_Factory) : It uses Factory binary which erases all user data in the memory when flashed to a device. (Clear user data)

- SVA (Fenrir_All) : It uses Factory and Home binaries. you can download Home and Factory binary in a PC (but requires double HDD storage and NW traffic)

2) Input ID & password

※ You need to reset the ID information in case of PC change and format and repair, hard disk change

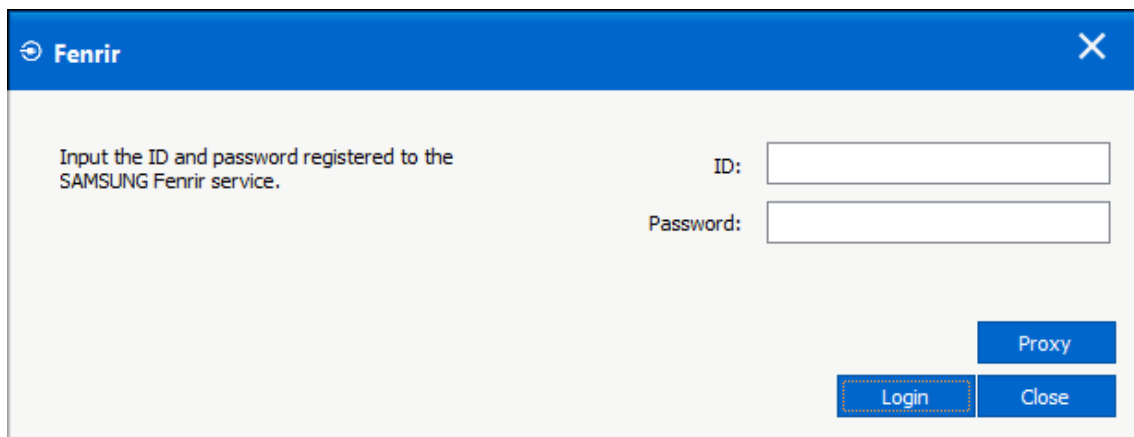
A screenshot of the Fenrir software interface. The window has a blue title bar with the 'Fenrir' logo and a close button. The main area is white and contains the text: 'Input the ID and password registered to the SAMSUNG Fenrir service.' Below this text are two input fields: 'ID:' and 'Password:'. At the bottom right, there are three buttons: 'Proxy', 'Login', and 'Close'. The 'Login' button is highlighted with a dashed border.

6. Level 1 Repair

3) Ensure device has sufficient charge (at least 20%) to start firmware update.

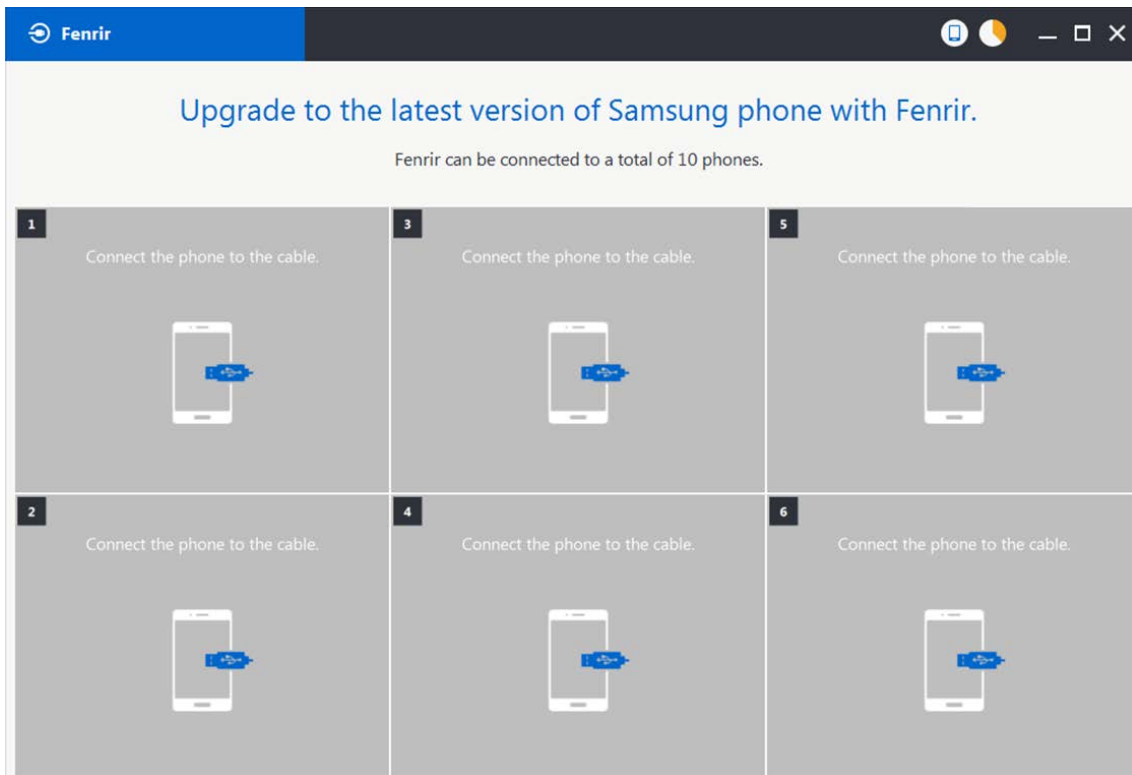

4) Connect the device to PC via data cable.

5) Upon USB connection, you will be presented with below screen.

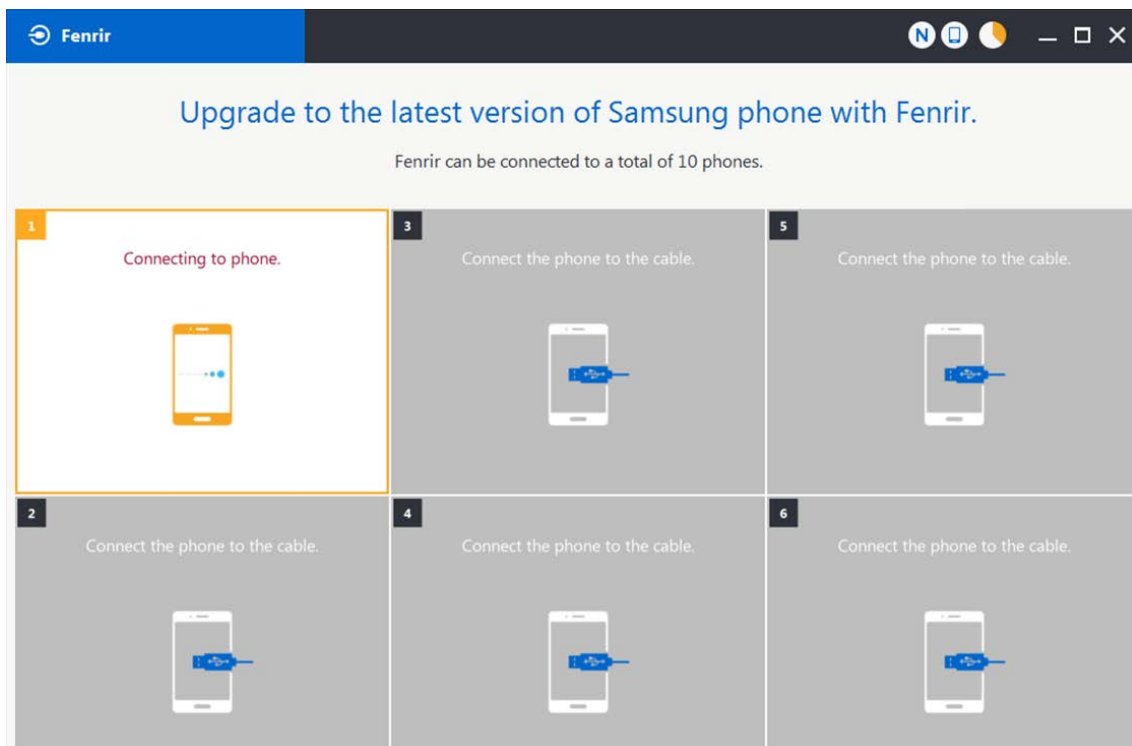

6. Level 1 Repair

6) Once device is detected, you will be presented with below screen. To update S/W, select “S/W Update” or to exit select “SVC Connection”. If you select “SVC Connection”, only Fenrir connection history (record) will be stored in the FUS server to support warranty validation. (This is known as “Service Connection” history)

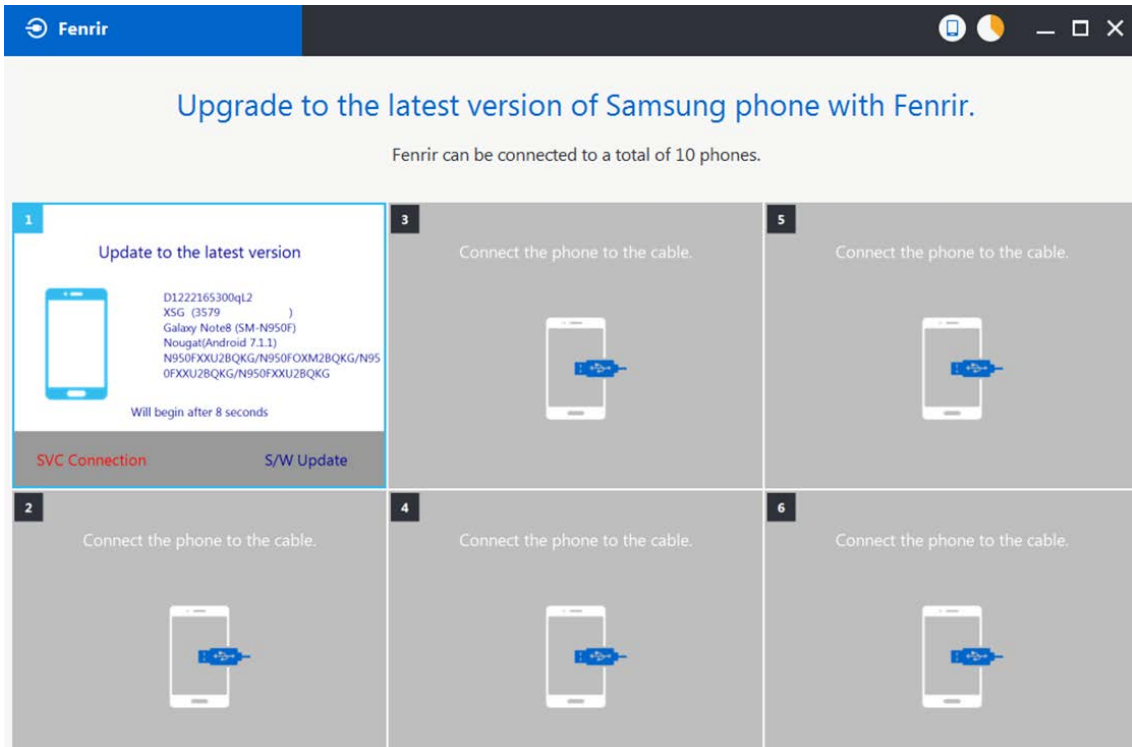

7) Once Fenrir starts, application will display the below screen. And select the Start button & Agree button.

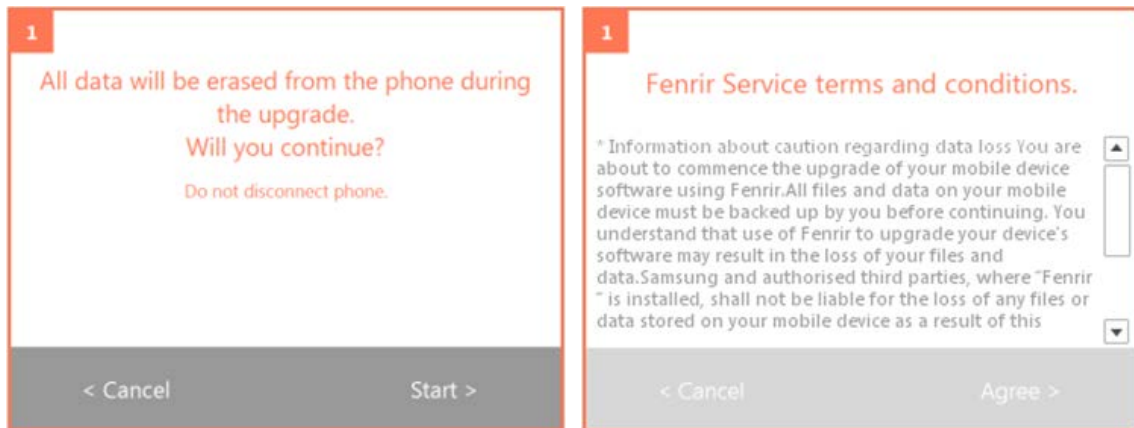

6. Level 1 Repair

8) The status circle increases as the update installs. The update process takes approximately 5-10 minutes to complete. Do not disconnect the device from USB during processing.

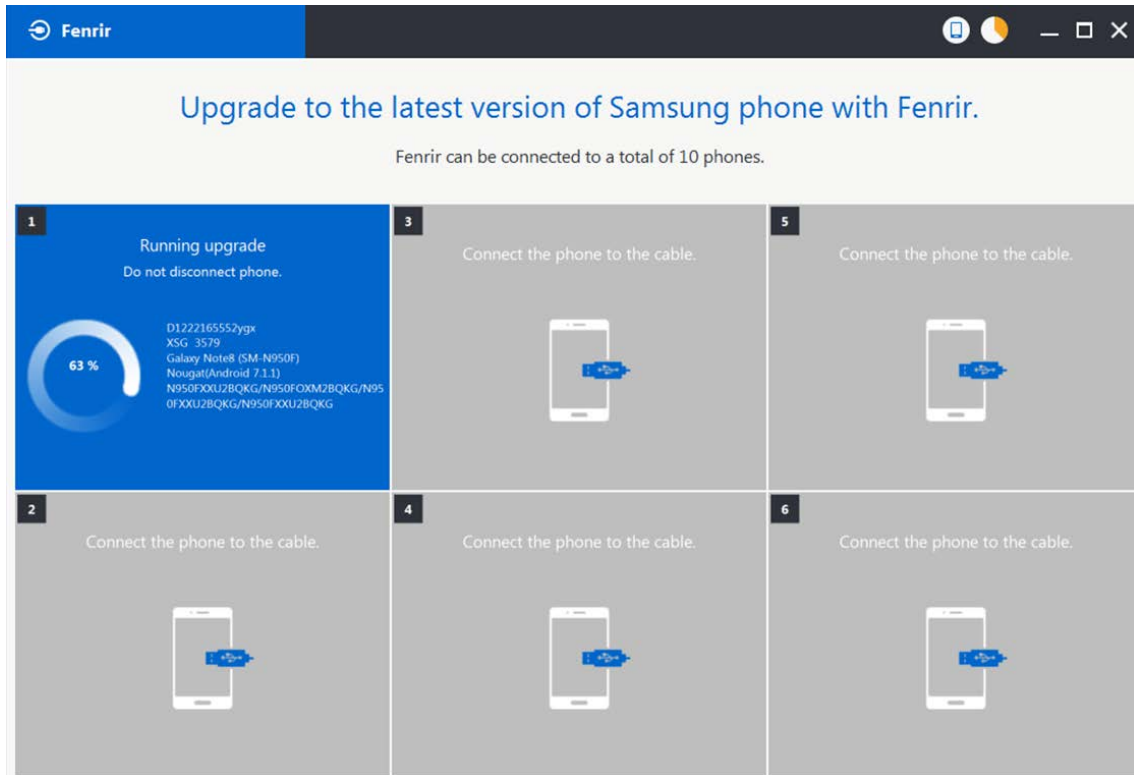

9) Once complete, application will present the below screen indicating update complete. Click Ok and detach device from USB.

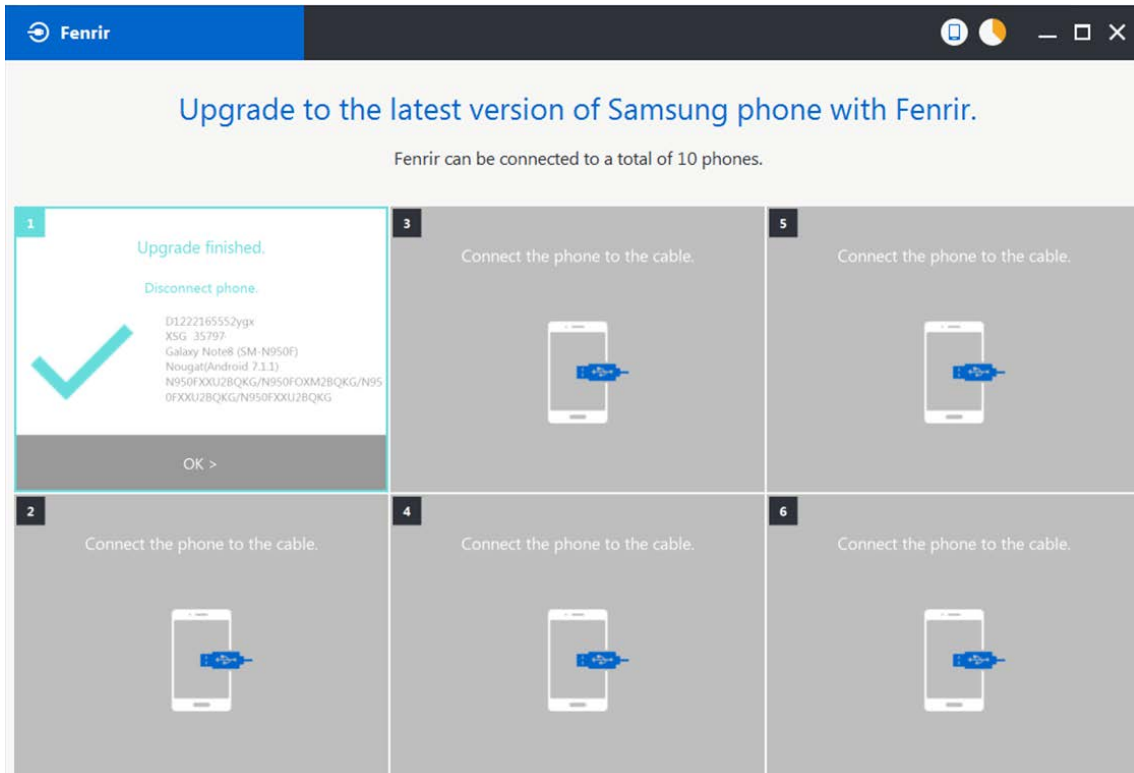

6. Level 1 Repair

6-2. How to use 'Odin' program

※ S/W Update via Fenrir is mandatory.

Below is the method to use 'Odin' program in any specific case.

6-2-1. Preparation

- Installation program : [Odin3 v3.13.2.exe or above](#)
- Mobile Phone
- Data Cable
- S/W Binary files (downloaded from GSPN)

※ Settings

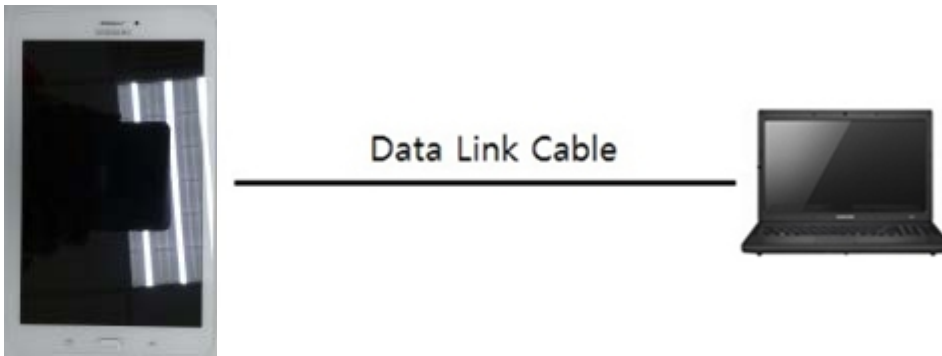

Data Cable : [GH39-01886A](#)

6. Level 1 Repair

6-2-2. S/W Installation Program (Downloader program)

Open up the S/W Installation Program by executing the "**Odin3 v3.13.2.exe**"

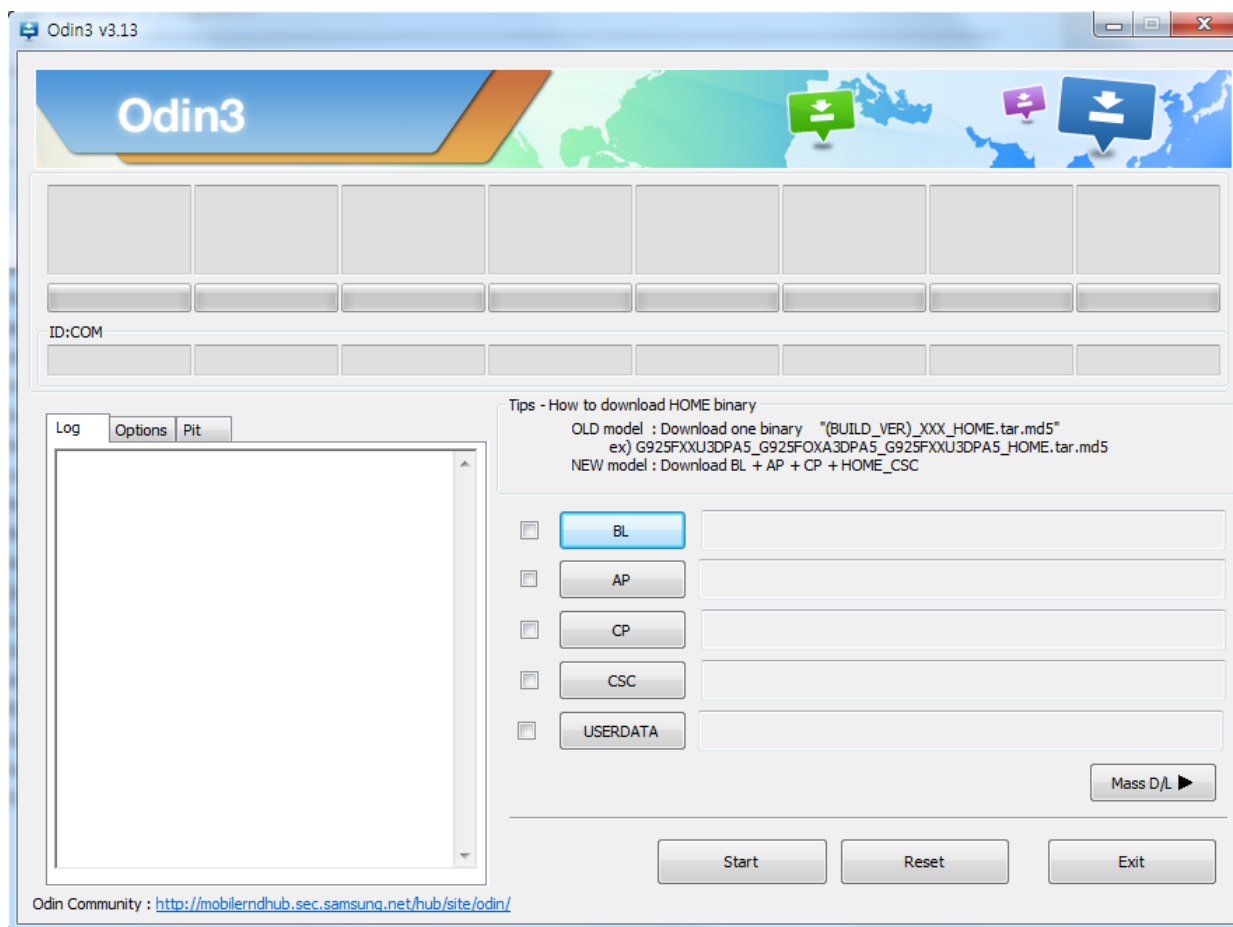

6. Level 1 Repair

1. Enable the check mark by click on the following options

- Check Auto Reboot, F. Reset Time, Nand Erase
- Check BL, AP, CP, CSC Files

* Note : "Odin v3.13.2 or above" checks MD5 checksum just after file selection.

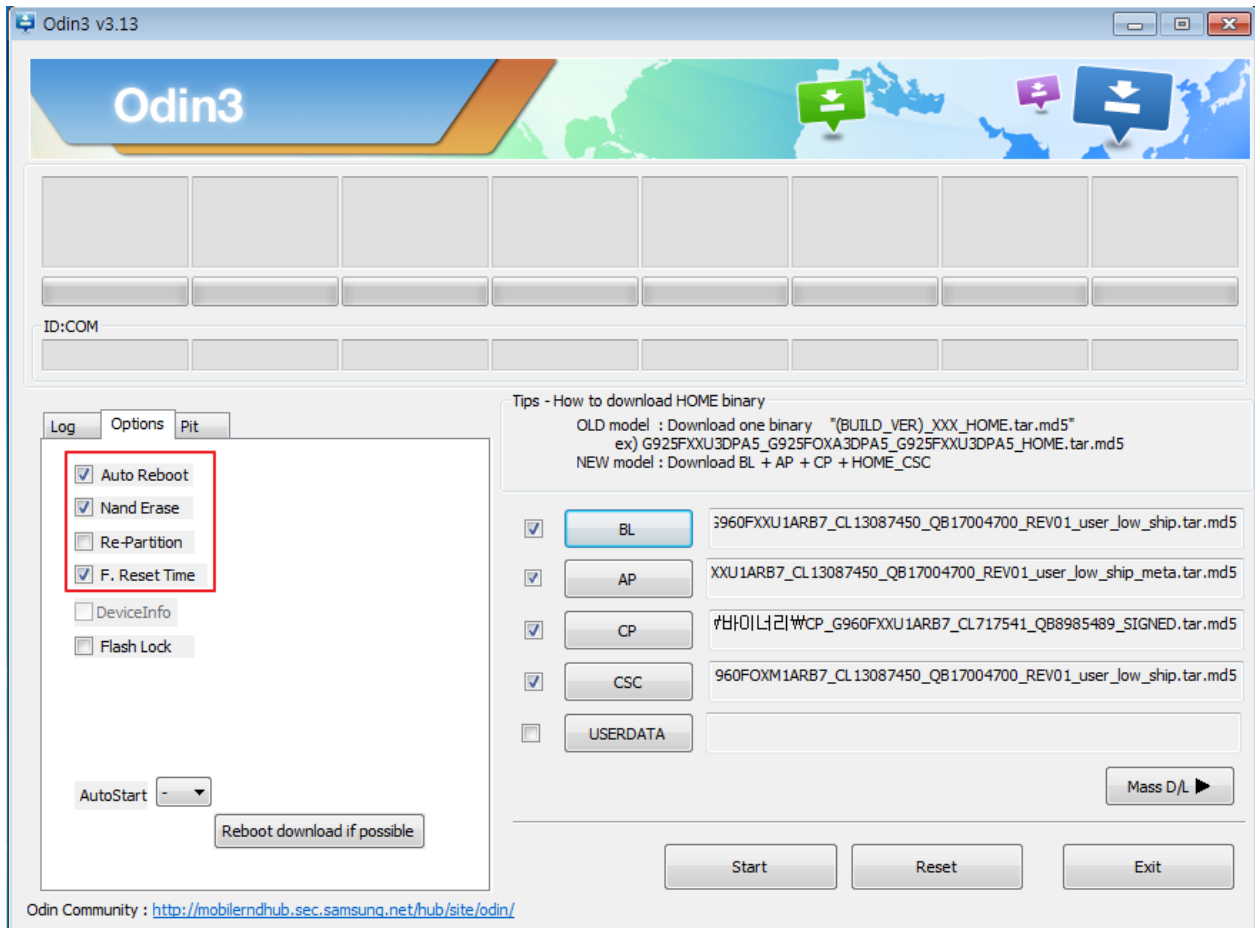

6. Level 1 Repair

2. Enter into Download Mode

- Enter into Download Mode by pressing Volume UP, Volume Down button and Connection USB Data cable.

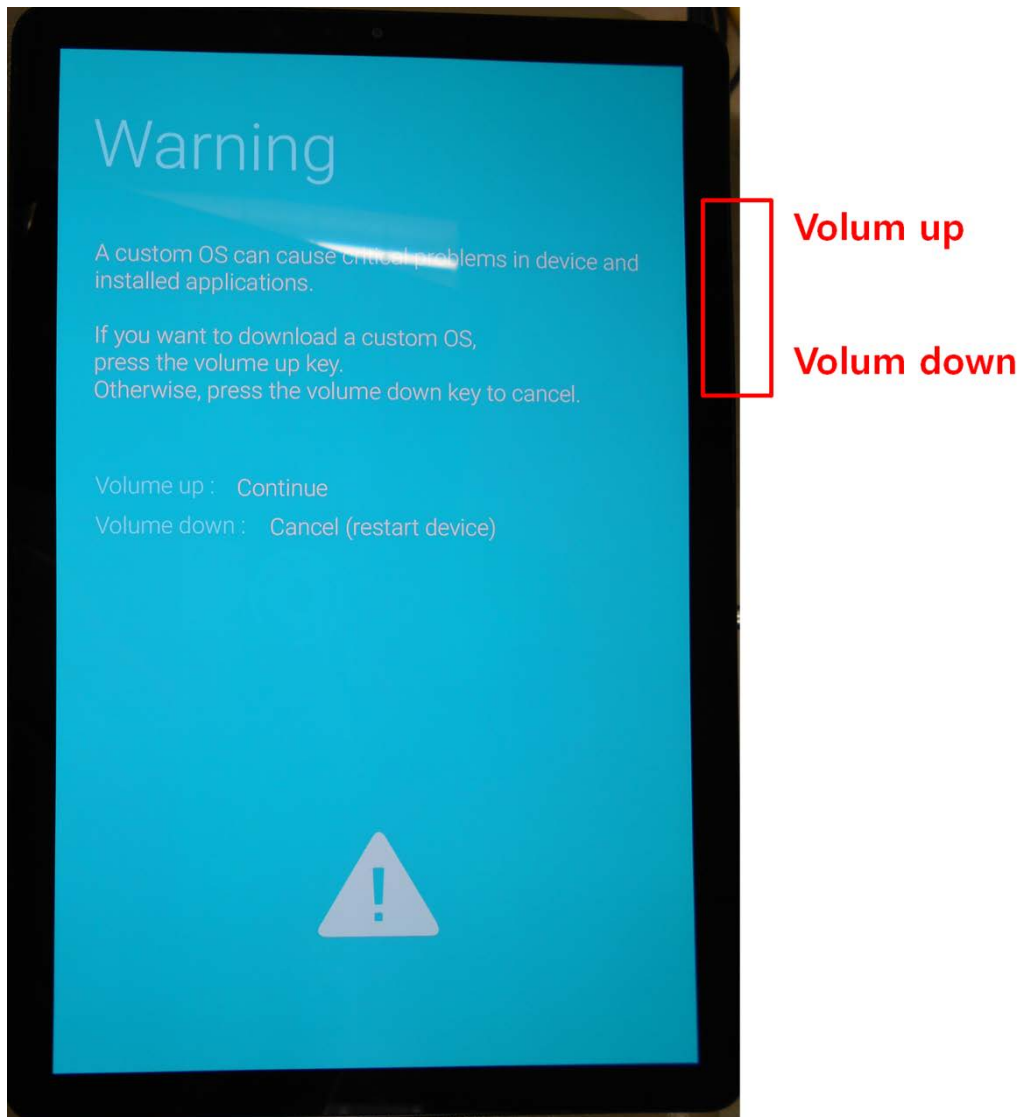

6. Level 1 Repair

3. Connect the device to PC via Data Cable.

Make sure that the one of communication ports [ID:COM] box is highlighted in sky blue. The device is now connected with the PC and ready to download the binary files in it.

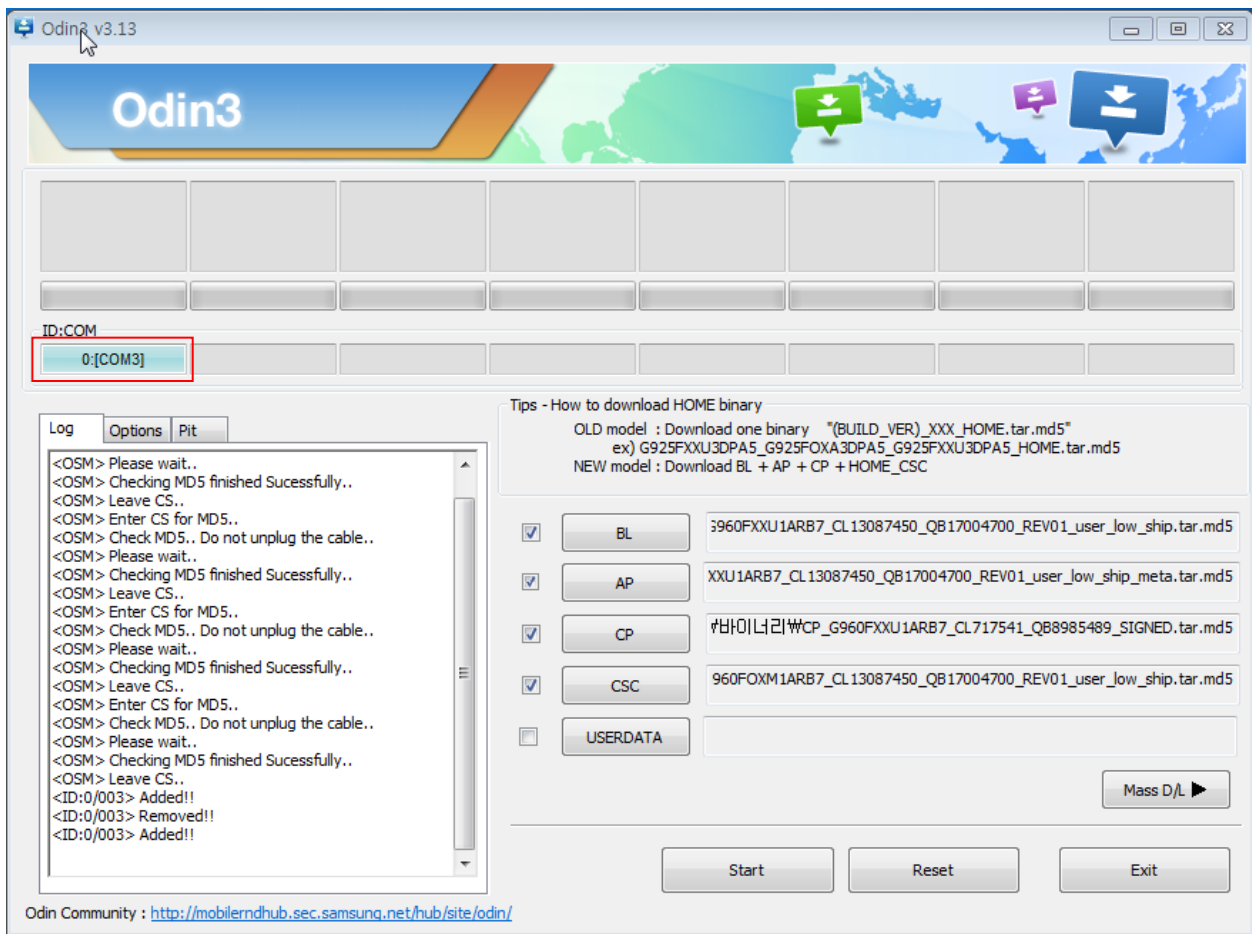

6. Level 1 Repair

4. Start downloading the binary files into the device by clicking Start button on the screen.

The green colored "PASS!" sign will appear on the upper-left box if the binary files have been successfully downloaded into the device.

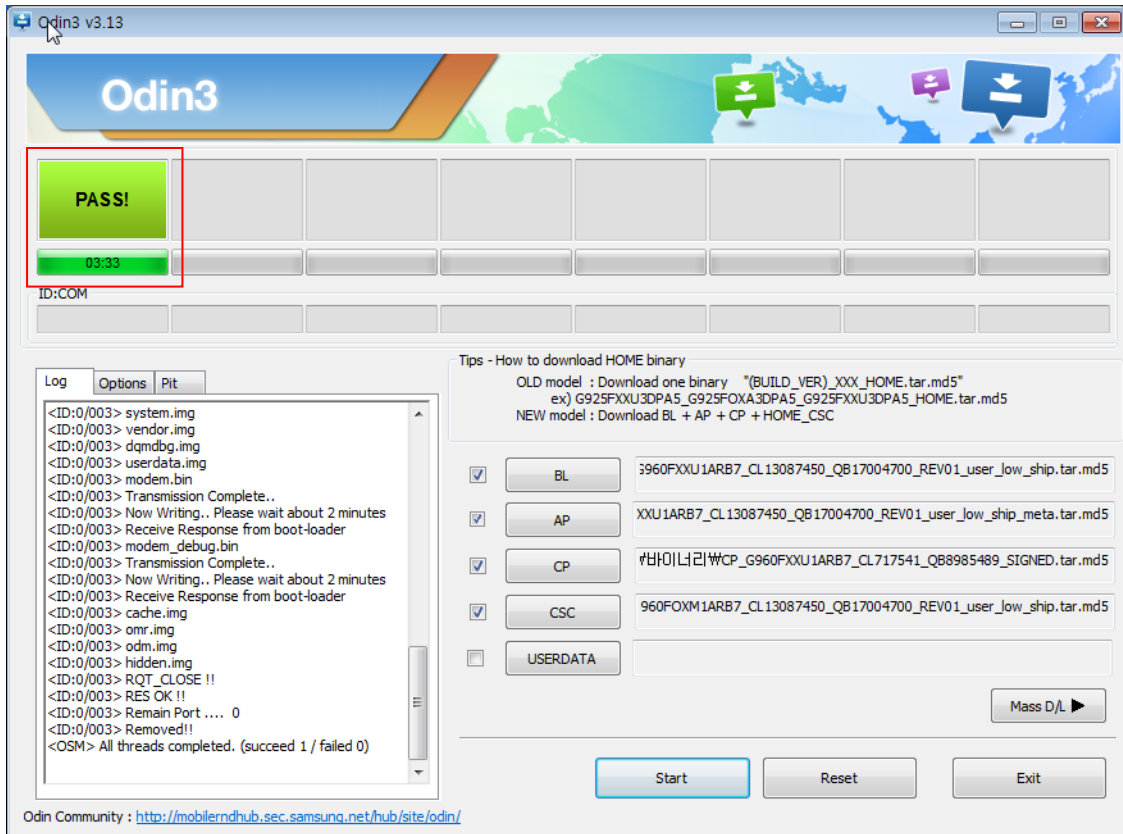

5. Disconnect the device from the Data cable.

6. Once the device boots up, you can check the version of the binary file or name by pressing the following code in sequence; ***#1234#**

You can perform Factory data Reset by Settings → General Management → Reset

※ Caution. Never disconnect during the S/W downloading.

6. Level 1 Repair

6-3. IMEI writing

6-3-1. Preparation

- New IMEI writing Program has been released.
- Supported Model : Models which CAB files are uploaded on HHPsvc INI File category, instead of ini file.
- Refer to below IMEI writing procedure.

- H/W

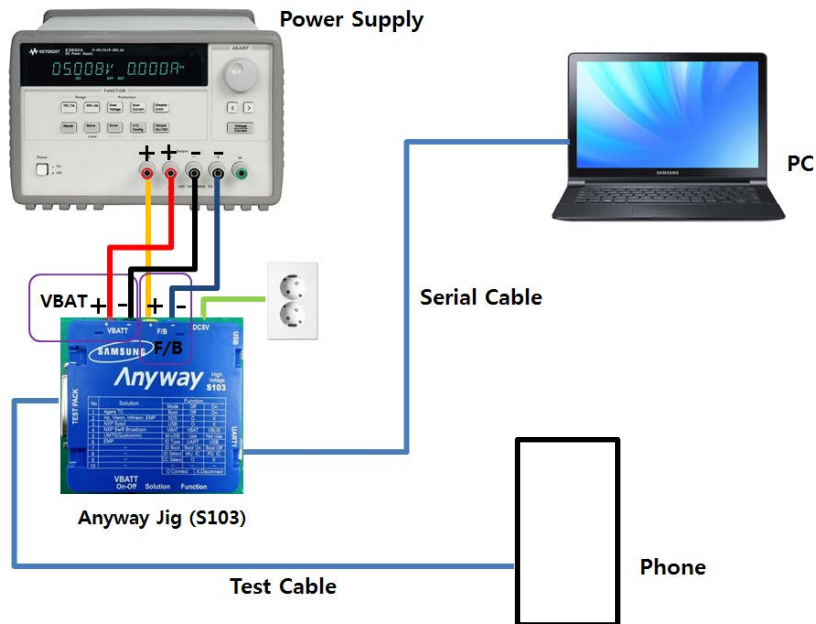

- S/W

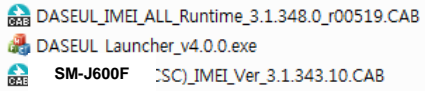
① Library Install	To use Daseul, library files should be installed. Refer to SVC Bulletin “(11-82) Daseul (New IMEI writing Program) Library Install guide_rev1.0”
② Launcher	DASEUL_SVC_Launcher_v3.0.12 or higher -Uploaded on HHPsvc Notice
③ Runtime File	1. DASEUL_IMEI_ALL_Runtime_3.1.348.0_r00519.CAB or higher -Uploaded on HHPsvc Notice 2. Make 'ModelName' folder at the same position with launcher & Runtime file. 
④ Model File	Copy Model File under the 'SM-J600F' folder

6. Level 1 Repair

6-3-2. IMEI writing Process

1. Run DASEUL_SVC_Launcher_v3.0.12.exe

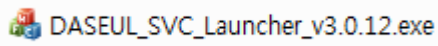

DASEUL_SVC_Launcher_v3.0.12.exe

2. Select Service Mode

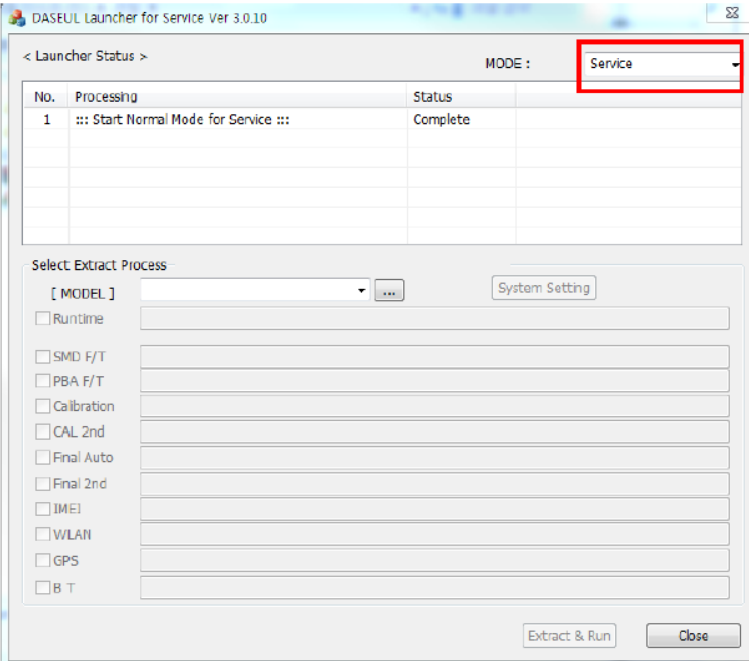

3. Click  and Select folder where the Launcher exists

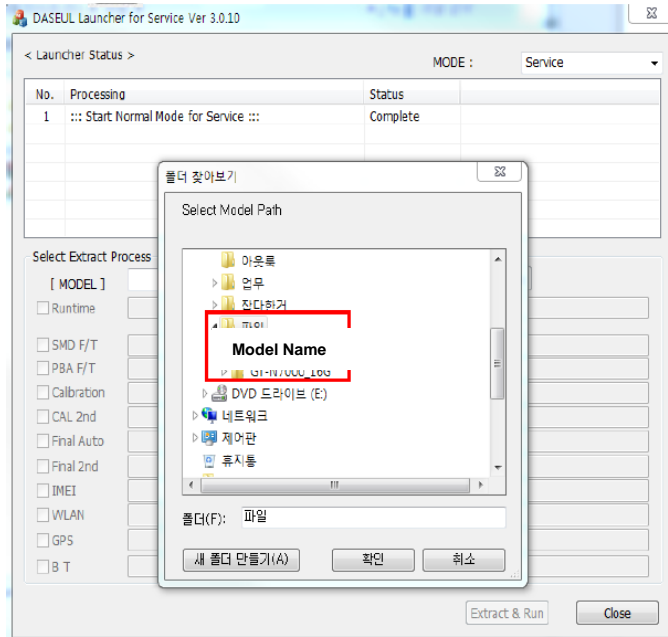

6. Level 1 Repair

4. Select Model

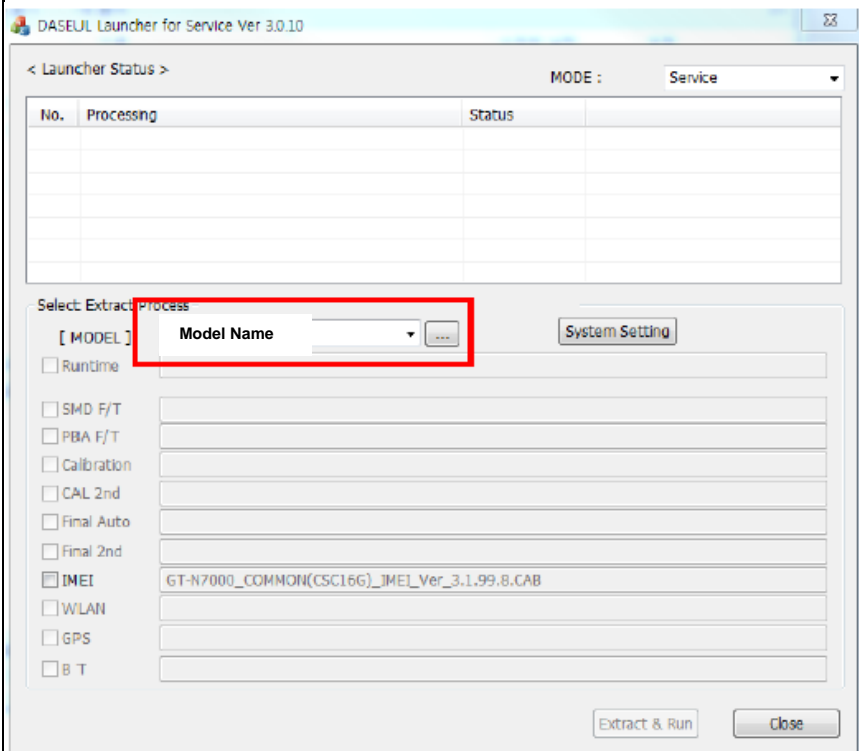

5. Check IMEI and click System Setting

※ Once you setup the setting, you don't have to do it again, unless there is change.
From second run of the IMEI program, check IMEI and click Extract & Run.

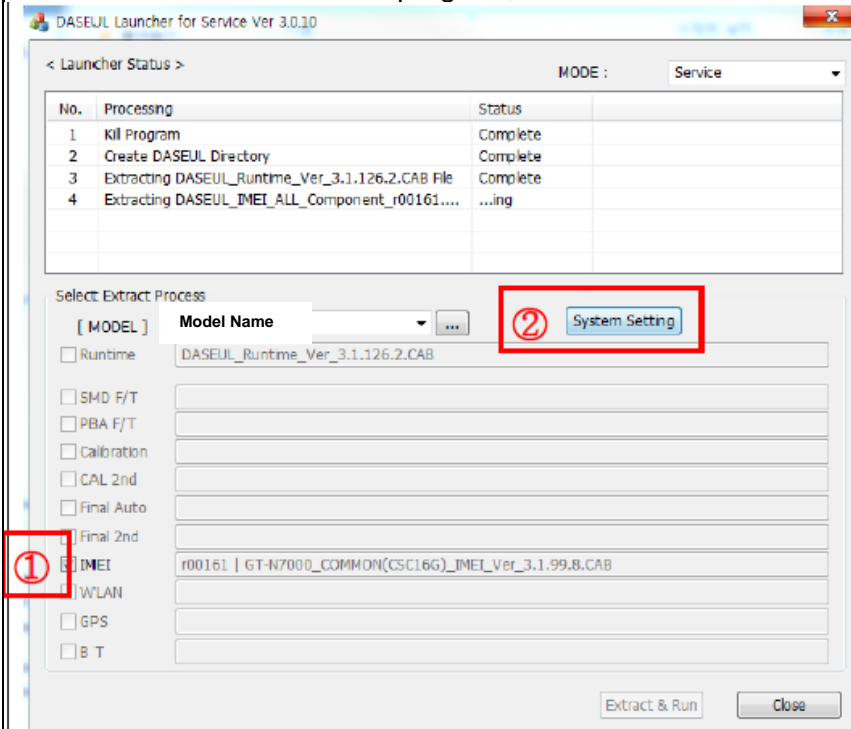

6. Level 1 Repair

6. Check IMEI Write / IMEI Check and click IMEI SVC & Repair Option.

Set System Configuration
Set System Configuration Dialog...

Test Process

[Process]	[Master]	[Slave]
SMD F/T	<input type="checkbox"/>	<input type="checkbox"/>
PBA F/T	<input type="checkbox"/>	<input type="checkbox"/>
Calibration	<input type="checkbox"/>	<input type="checkbox"/>
Calibration 2ND	<input type="checkbox"/>	<input type="checkbox"/>
Final Auto	<input type="checkbox"/>	<input type="checkbox"/>
Final Auto 2ND	<input type="checkbox"/>	<input type="checkbox"/>
Final Manual	<input type="checkbox"/>	<input type="checkbox"/>
IMEI Write	<input checked="" type="checkbox"/>	<input type="checkbox"/>
IMEI Check	<input checked="" type="checkbox"/>	<input type="checkbox"/>
MDL +2nd Check	<input type="checkbox"/>	<input type="checkbox"/>
MDL Rework	<input type="checkbox"/>	<input type="checkbox"/>
IMEI Read	<input type="checkbox"/>	<input type="checkbox"/>
STA Write	<input type="checkbox"/>	<input type="checkbox"/>
STA Check	<input type="checkbox"/>	<input type="checkbox"/>
STA Reset	<input type="checkbox"/>	<input type="checkbox"/>
WLAN	<input type="checkbox"/>	<input type="checkbox"/>
GPS	<input type="checkbox"/>	<input type="checkbox"/>
BT	<input type="checkbox"/>	<input type="checkbox"/>
WLAN	<input type="checkbox"/>	<input type="checkbox"/>
Power Off-On before WLAN	<input type="checkbox"/>	<input type="checkbox"/>
Bluetooth	<input type="checkbox"/>	<input type="checkbox"/>
LCIA	<input type="checkbox"/>	<input type="checkbox"/>
Merge 2G3G Block Rad.	<input type="checkbox"/>	<input type="checkbox"/>

Test Condition

Calibration
Real CAL Cycle: on every default CALs

Calibration Mode :

CAL2nd Mode :

Final
Supply RF Signal by :

Reset Loss Correction Count

Test Mode :

WLAN
Test Mode :

IMEI
Use RFSM
Use Second PC
Save ODS
Merge Felica Cal
OQC Reset
IBI Reset

System Config.

Language :

Line Name :

Line Type :

Smart Cloud Cell

of Phone :

Start Number of UI :

Start Number of Jig :

IP Address : 10.244.246.156

SKD Mode

MultiSharing(CMWS)

Developer Mode

Advanced Separating(ADS)

Operation Condition

7. Check 'SVC , User Ticket No' and click OK

IMEI SVC && Repair Option

FTR Rework Korean SVC

SVC SELA MIAMI Local FOTA Check

DEVELOPE Repair Board SVC Factory Reset

Romania SVC Argentina SKD

Initial PGM(SVC) Turkey

ATT Rework Slovakia SVC

IMEI Clear(Factory) GED 2nd Inspection

Outgoing Inspection Check SBSC(PBA) SVC

6. Level 1 Repair

8. Click 'Hardware Config'

Set System Configuration
Set System Configuration Dialog...

Test Process

[Process]	[Master]	[Slave]
SMD F/T	<input type="checkbox"/>	<input type="checkbox"/>
PBA F/T	<input type="checkbox"/>	<input type="checkbox"/>
Calibration	<input type="checkbox"/>	<input type="checkbox"/>
Final Auto	<input type="checkbox"/>	<input type="checkbox"/>
Final Manual	<input type="checkbox"/>	<input type="checkbox"/>

IMEI Process

IMEI Write	<input checked="" type="checkbox"/>	<input type="checkbox"/>
IMEI Check	<input checked="" type="checkbox"/>	<input type="checkbox"/>
MDL+2nd Check	<input type="checkbox"/>	<input type="checkbox"/>
MDL Rework	<input type="checkbox"/>	<input type="checkbox"/>
IMEI Read	<input type="checkbox"/>	<input type="checkbox"/>

WLAN
Power Off-On before WLAN
Bluetooth

Test Condition

Calibration
Real CAL Cycle: on every
20 default CALs
Calibration Mode: Dynamic

Final
Supply RF Signal by: Conduction

Test Signal Mode: Signaling

Developer Mode

IMEI

Use RFSM
Use Second PC
Save ODS

System Config.

Language: English
Line Name: LINE(temp)
Line Type: Block Cell
of Phone: 1
Start Number of Jig: 1
IP Address: 10.244.114.62

Operation Condition

Model Information
Hardware Config
Signal Loss Config.
Terminal Config.
MST's Calibration
Setting End Band

IMEI SVC&Repair Option
Operation Condition
OK

9. Click 'Port Setting'

Hardware Component Configuration
Controller Type, IO Bus Type, Port Setting,...

Phone

Count: 1
I/F - 1 Type: Serial COM
I/F - 2 Type: N/A
IF Jig Type: AnyWayJig
 Use ID Check JIG

MSTS Sharing Controller

Count: 0
Control Type: N/A
I/F Type: Serial COM
Terminal
Port Setting

Robot / ShieldBox

Control Type: N/A
I/F Type: Serial COM
Port Setting

Power Supply

I/F Type: GPIB
Port Setting

DBMS

Server: HOME(GUMI)
Type: Outside-Socket

Barcode Reader

Type: N/A
I/F Type: Serial COM
Port Setting

MES PN Sender

Type: N/A
Port Setting

PBA F/T

Function Test Jig
NI-DAQ
Power Detector
HDMI JIG
Port Setting
Port Setting
Port Setting
Port Setting

MSTS

Count: 0
I/F Type: GPIB
Port Setting

SMD F/T

Type: N/A
B'd Address: 5
Port Setting

SAVE
Cancel

6. Level 1 Repair

10. Select Port Number and SAVE

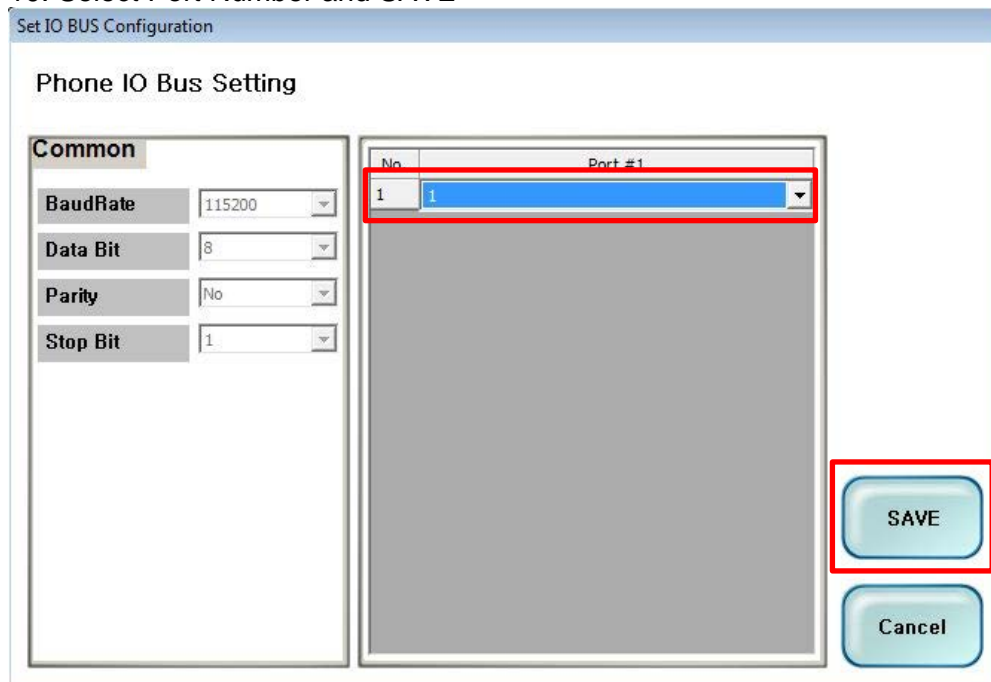

The image shows a dialog box titled "Set IO BUS Configuration" with a sub-header "Phone IO Bus Setting". On the left, there is a "Common" section with four dropdown menus: "BaudRate" (115200), "Data Bit" (8), "Parity" (No), and "Stop Bit" (1). On the right, there is a table with two columns: "No." and "Port #1". The first row contains the number "1" in both columns, and this row is highlighted with a red border. Below the table are two buttons: "SAVE" and "Cancel", with the "SAVE" button also highlighted by a red border.

No.	Port #1
1	1

11. Click OK to proceed

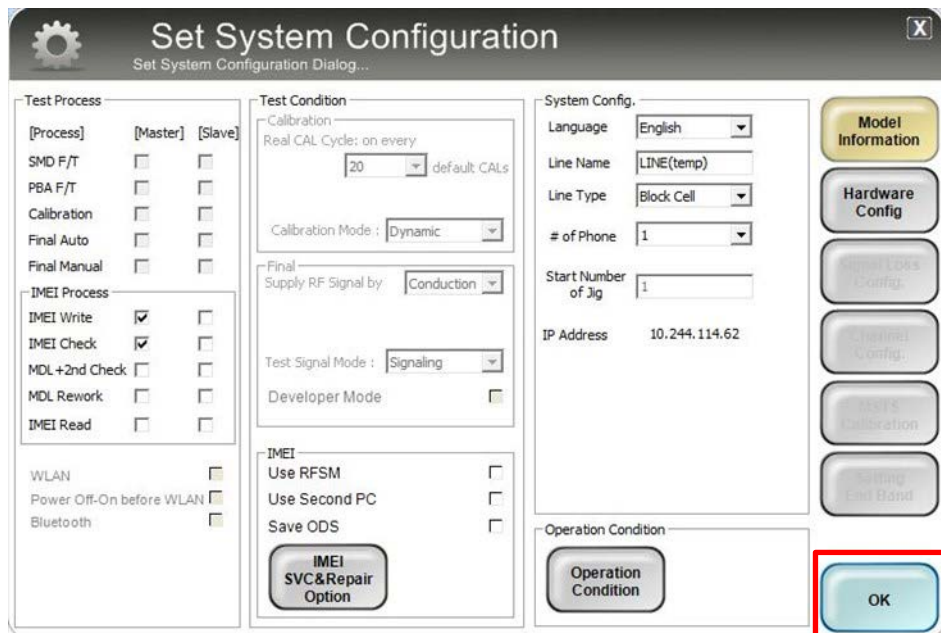

The image shows a dialog box titled "Set System Configuration" with a sub-header "Set System Configuration Dialog...". It is divided into several sections: "Test Process" (with checkboxes for SMD F/T, PBA F/T, Calibration, Final Auto, Final Manual, IMEI Write, IMEI Check, MDL +2nd Check, MDL Rework, IMEI Read, WLAN, Power Off-On before WLAN, and Bluetooth); "Test Condition" (with dropdowns for Real CAL Cycle, Calibration Mode, Final Supply RF Signal, and Test Signal Mode, and checkboxes for Developer Mode, IMEI Use RFSM, Use Second PC, and Save ODS); "System Config." (with dropdowns for Language, Line Name, Line Type, # of Phone, and Start Number of Jig, and a text field for IP Address); and "Operation Condition" (with a button for "Operation Condition"). On the right side, there is a vertical stack of buttons: "Model Information", "Hardware Config", "Appl Loss Config", "Channel Config", "Start Calibration", "Setting End Band", and "OK". The "OK" button is highlighted with a red border.

6. Level 1 Repair

12. Click Model Info and OK when pop-up shows

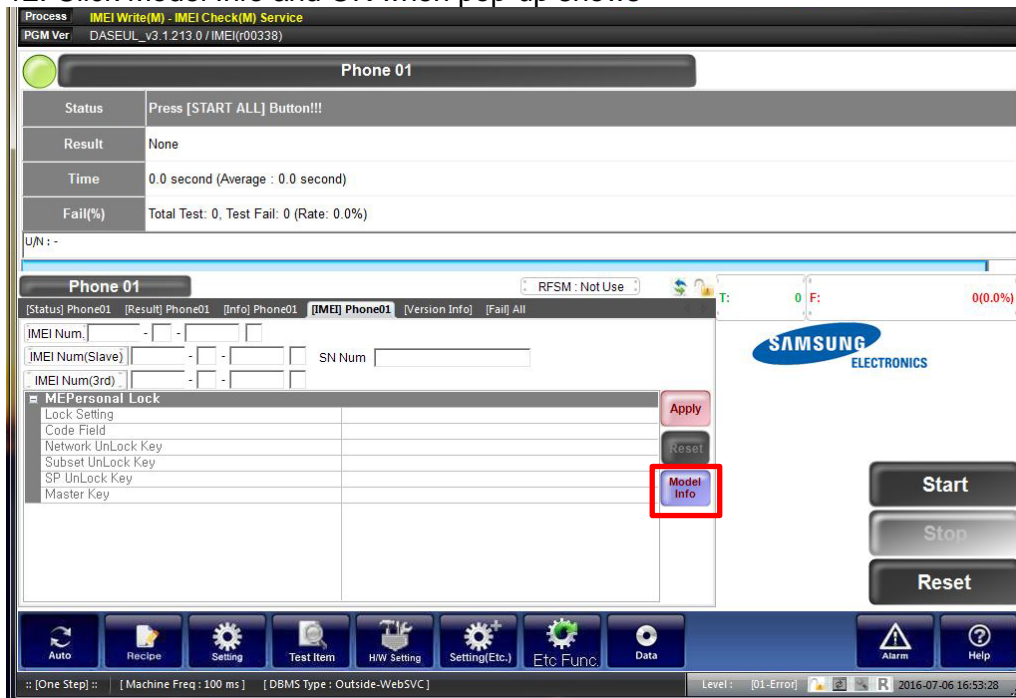

13. Click OK

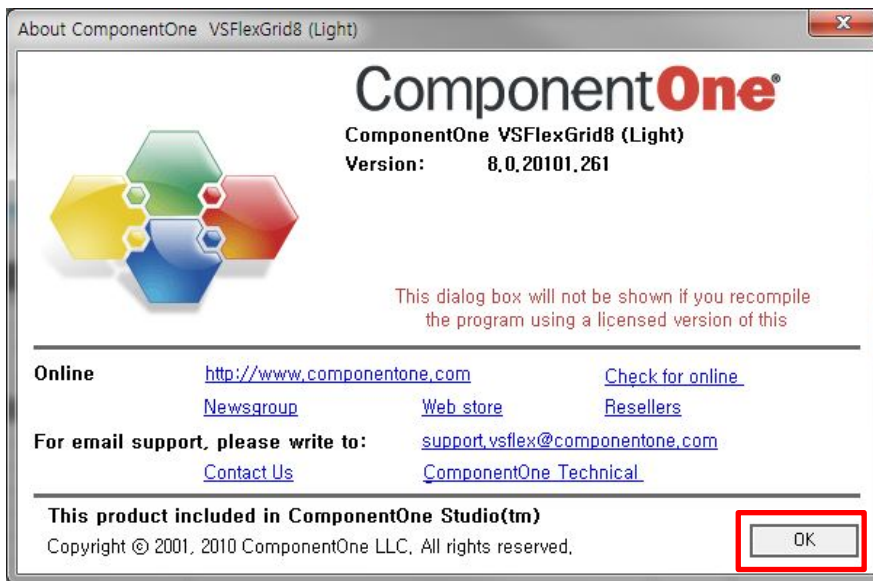

6. Level 1 Repair

14. Input SKU_CODE and BUYER, then click Save button.

※ Refer to HHPsvc→IMEI Review to check SKU Code and buyer

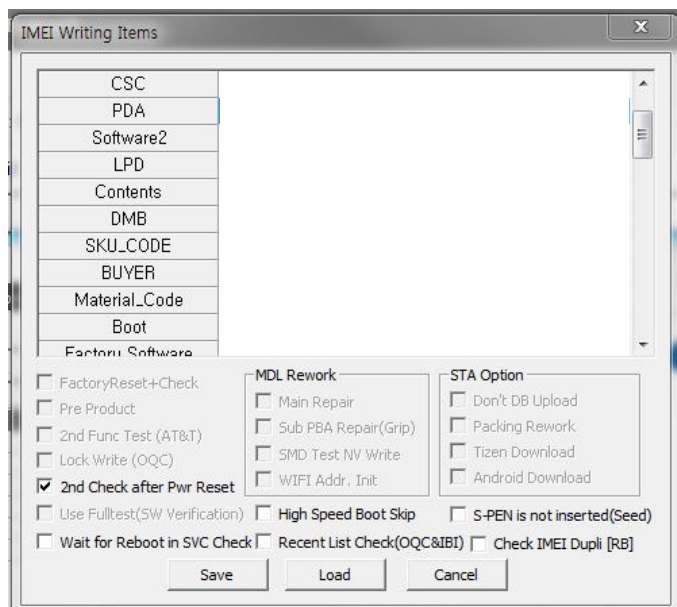

15. Input IMEI Number and click Apply

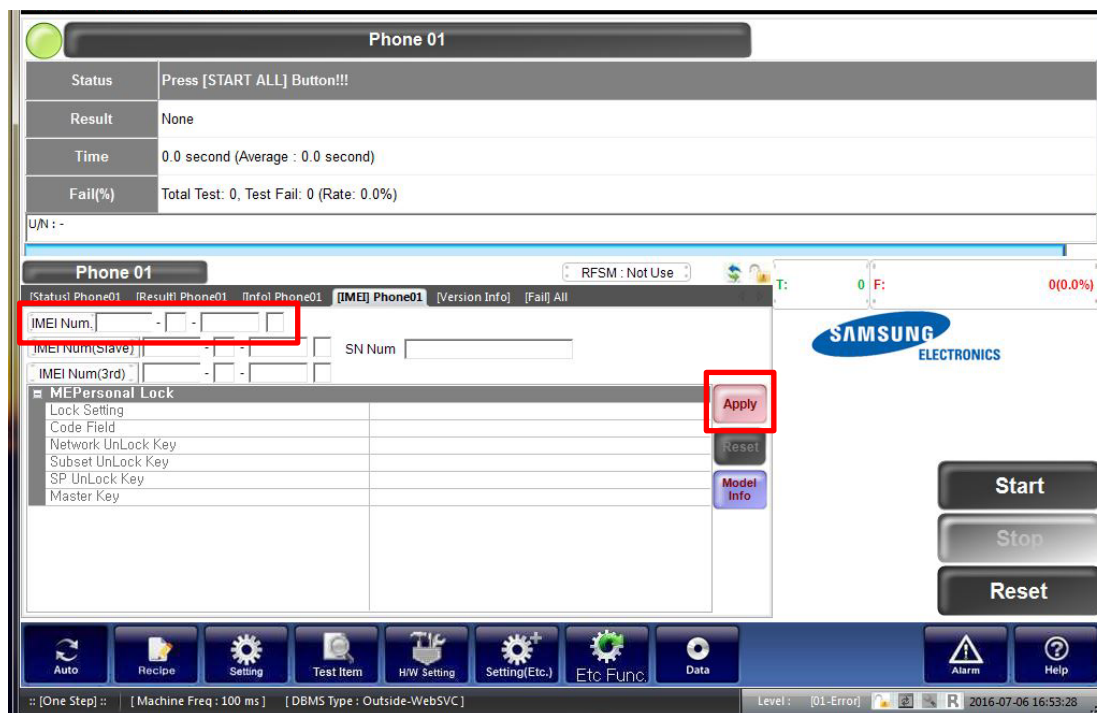

6. Level 1 Repair

16. ① Click Start → ② Input IMEI writing ID and Password & OTP → ③ Input Ticket No

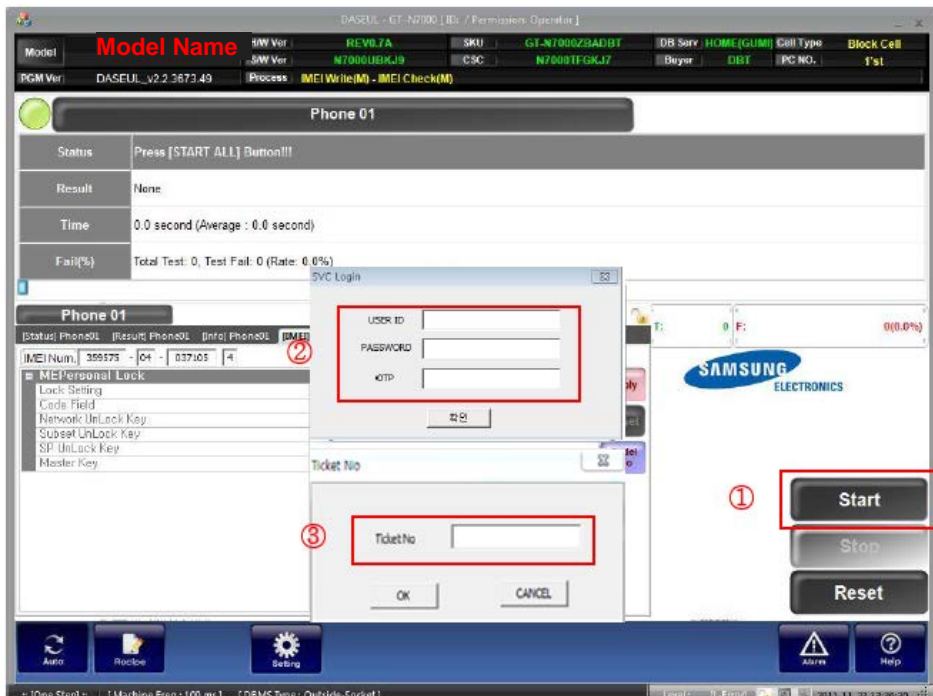

※ OTP(One time Password) : OTP is valid for 6 hours.

After that, you can get new OTP by click the “Forgotten your IMEI OTP PW or Create new IMEI OTP PW” button.

☞ OTP Location : GSPN → Knowledge → HHP svc → Home

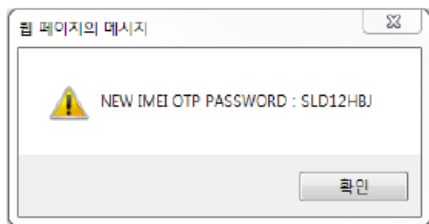
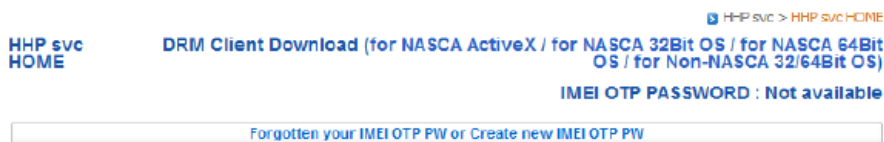

6. Level 1 Repair

17. Connect the phone to Anyway JIG

- ※ When you connect the phone, the phone should be turned off.
After connecting the phone, the phone will be booted automatically.

18. IMEI Writing Proceeding

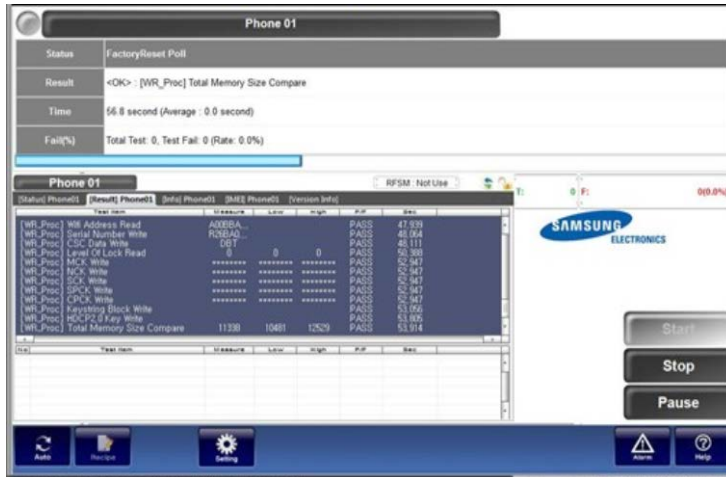

19. IMEI Writing Success

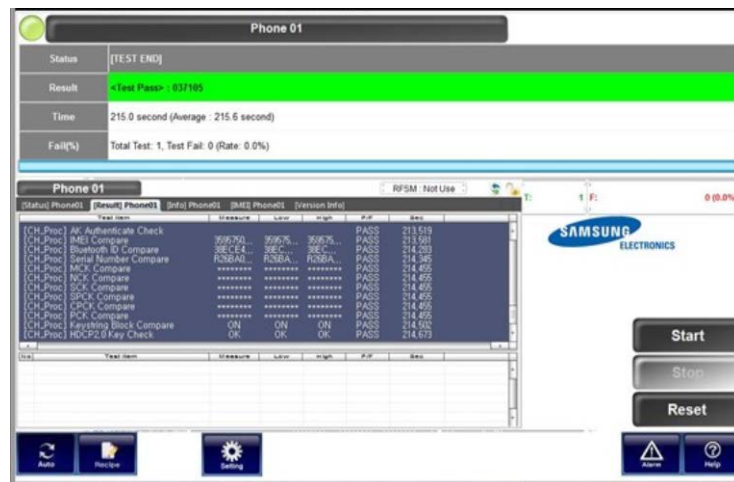

6. Level 1 Repair

6-4. RF Calibration

6-4-1. Required items in order to calibrate RF

- Installation program: RF Calibration Program
- Daseul_Launcher_vx.x.xx.exe
- Daseul_CAL_ALL_Runtime_x.x.xxx.x.CAB
- Model File
- : [Model Name_OPEN_CALIBRATION_Ver_x.x.xxx.x.CAB](#)

※ It is required to use the latest program.

- Mobile Phone
- R&S CMW500
- E3632A Power Supply
- GPIB Cable (2ea)
- JIG BOX (S103)
- Adapter
- UART Serial Cable
- IF Cable (GH81-11962W)

❖ Table of test cables

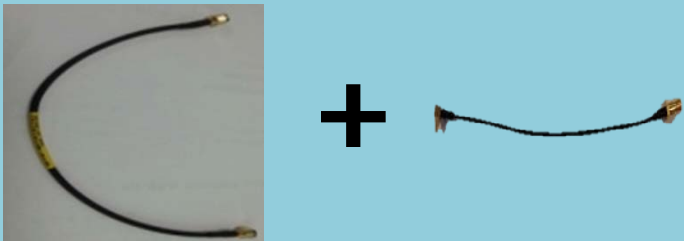
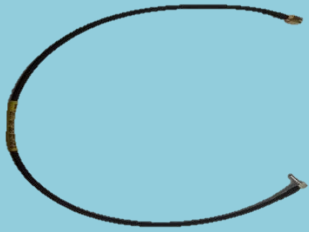
RF Cable (Manual)	GH81-11962U (2EA) + GH81-11962M (2EA)		GH81-11962D (2EA)
			
4 Port Divider	GH81-11962A Divider 1 ea	GH81-11962B Divider cable 1ea	No 50Ω Termination

6. Level 1 Repair

❖ Setting

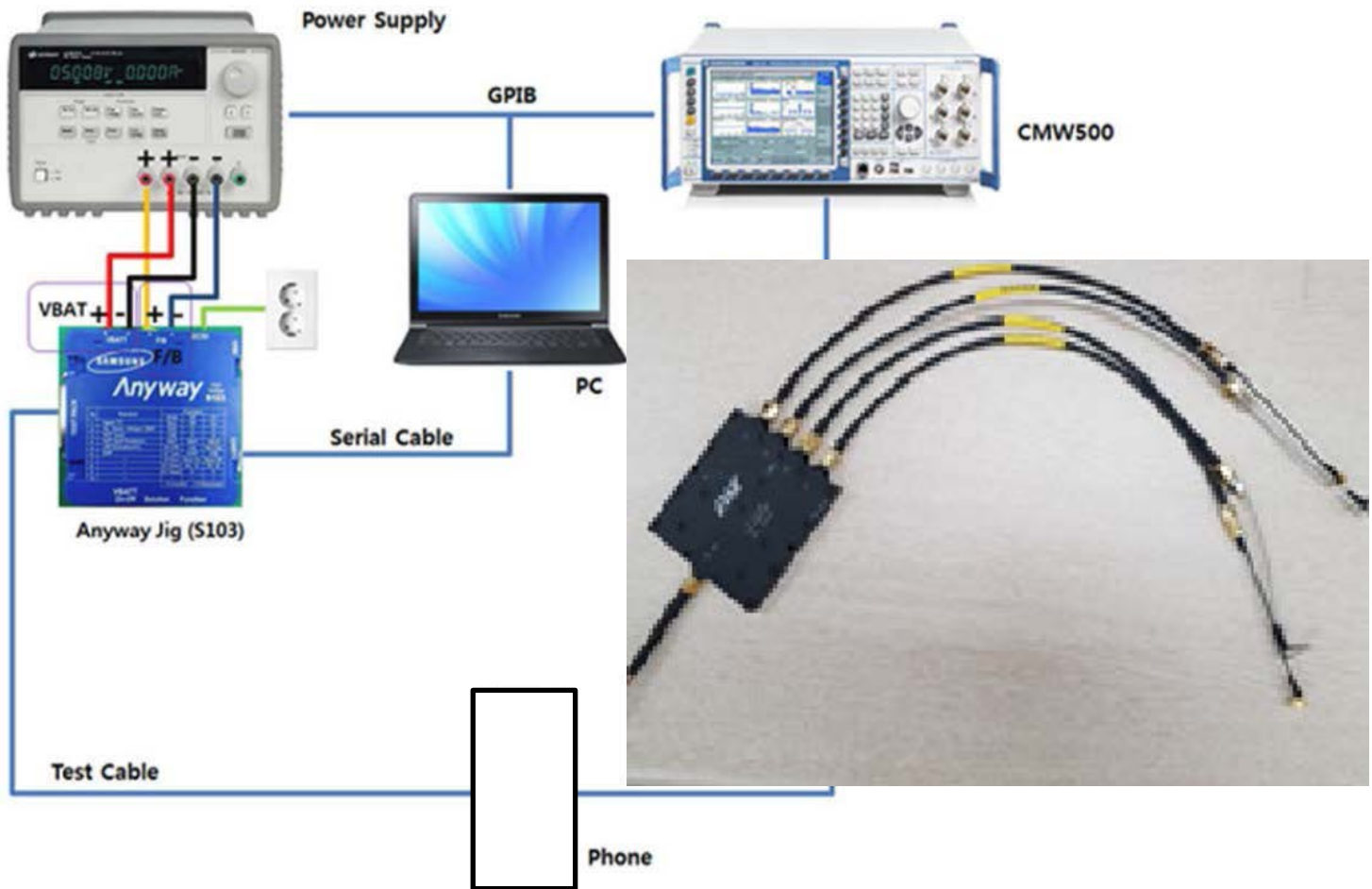

6. Level 1 Repair

6-4-2. RF Calibration Program

1. Run the RF Calibration Program Launcher, 'DASEUL_Launcher_vx.x.xx.exe'.

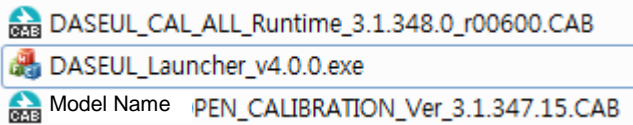

2. Check the 'Calibration' option and Click 'Extract & Run'.

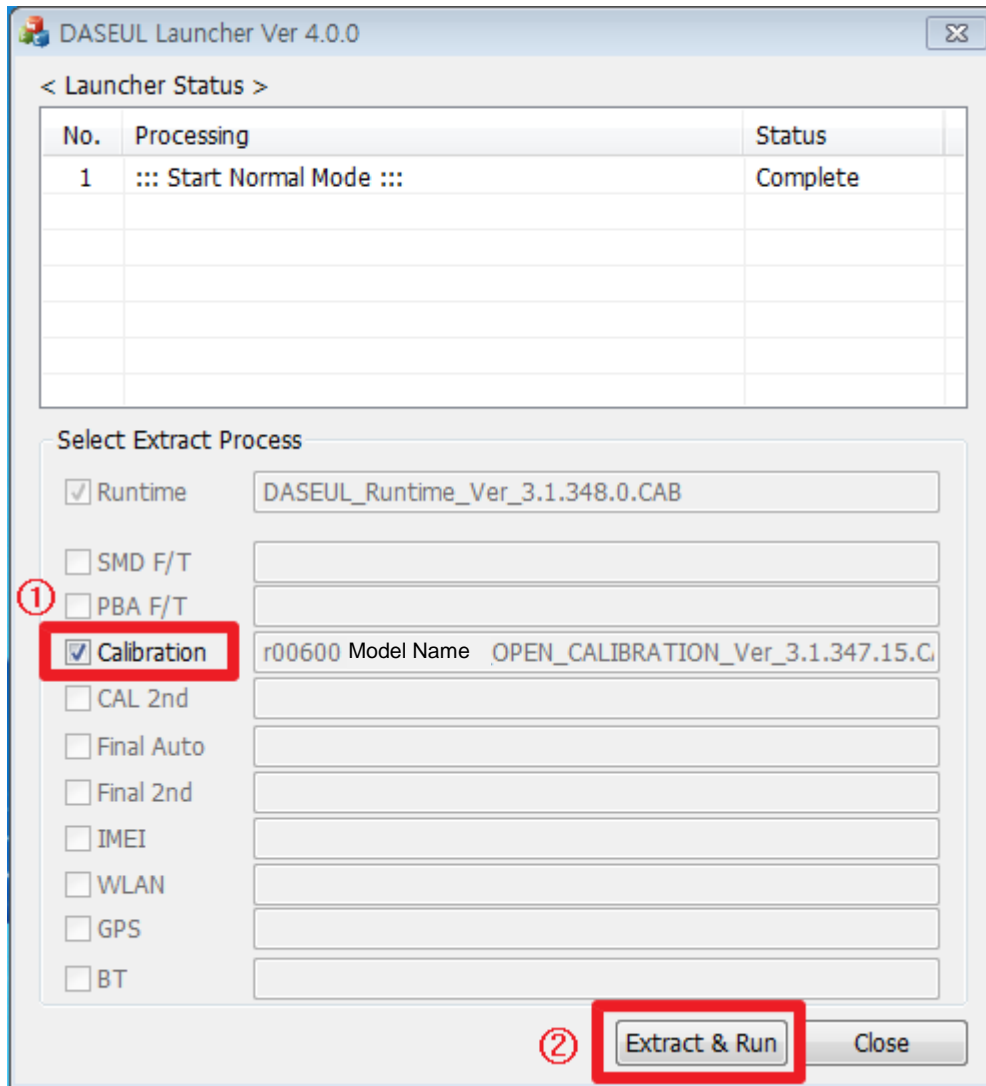

6. Level 1 Repair

3. Check the 'CAL' and open the [model file](#), then select 'Start' button.

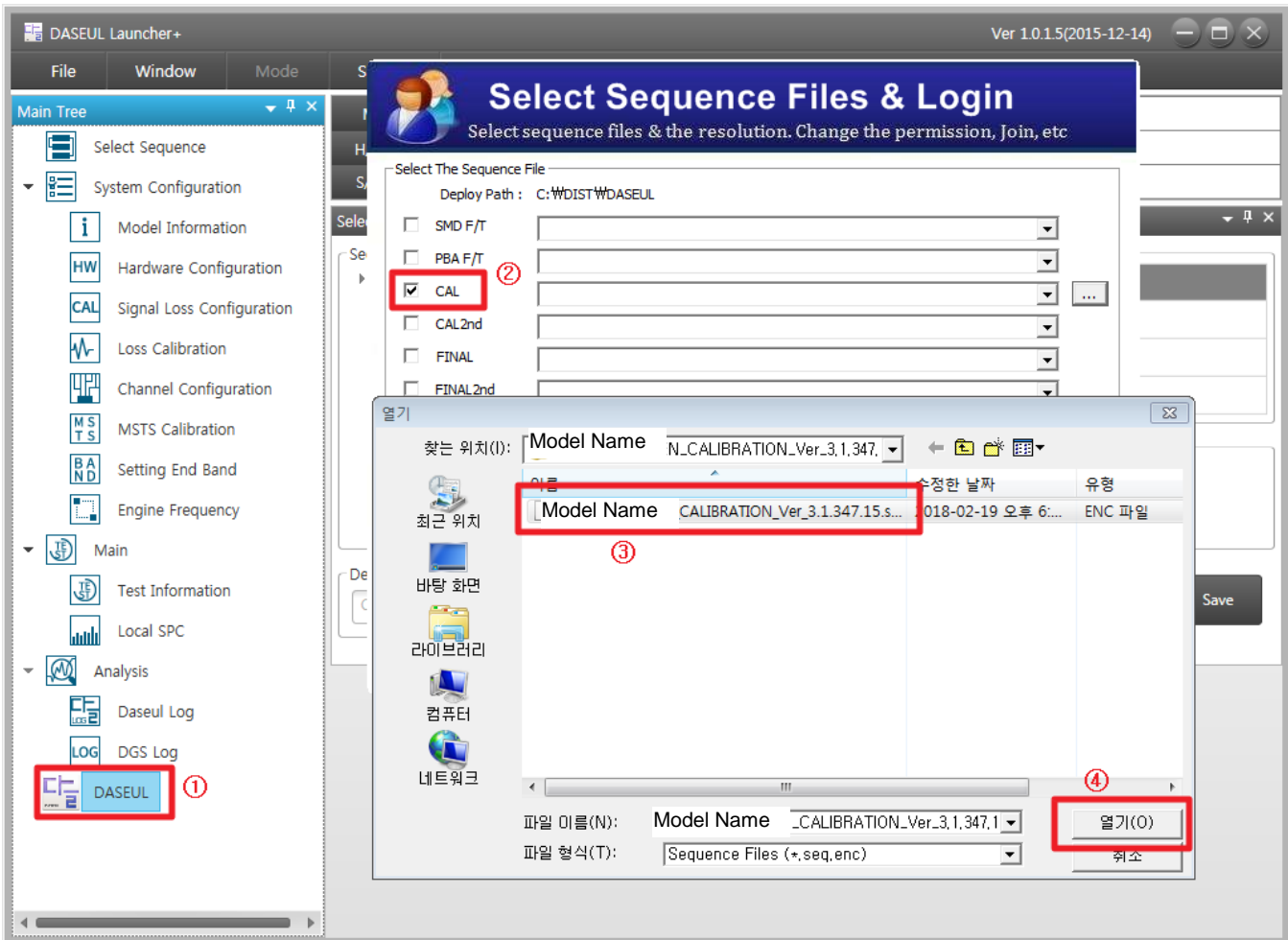

6. Level 1 Repair

4. Change the Line Type to 'Block Cell' and disable 'Smart Cloud Cell'.

The screenshot shows the 'Set System Configuration' dialog box with the following settings:

- Test Process:** Calibration is checked under the [Master] column.
- Test Condition:** Calibration Mode and CAL2nd Mode are both set to FDT. Test Mode is Signaling.
- System Config.:** Language is Korean, Line Name is LINE(temp), Line Type is Block Cell, and Smart Cloud Cell is unchecked. NP Cell is also unchecked.
- Operation Condition:** Operation Condition and RUN SeeLog buttons are visible.

6. Level 1 Repair

5. Set the GPIB address of MSTS(CMW500) and Power Supply(E3632A) to enter 'Hardware Config' and 'Save'. (Check the GPIB address of equipments in advance)

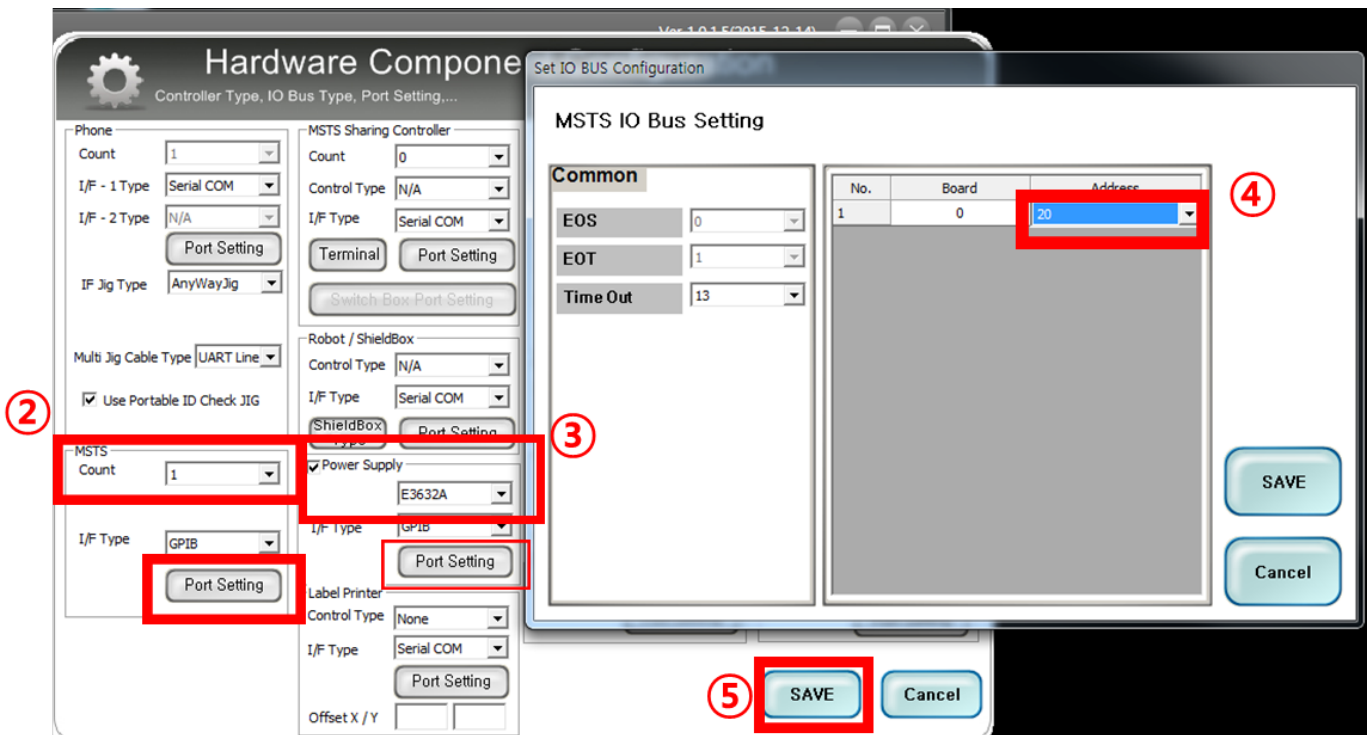
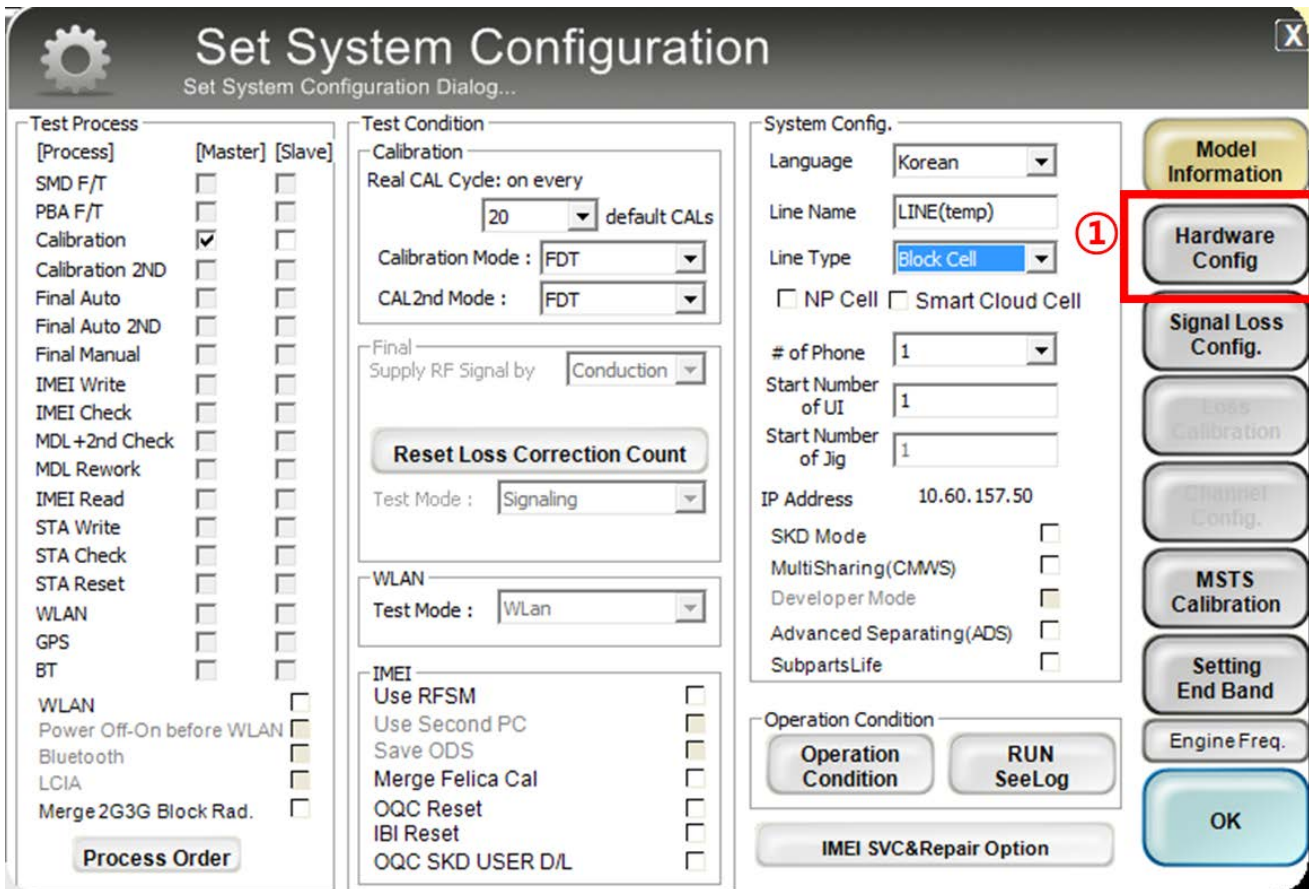

6. Level 1 Repair

6. Press 'OK' to start RF Calibration after completing all settings.

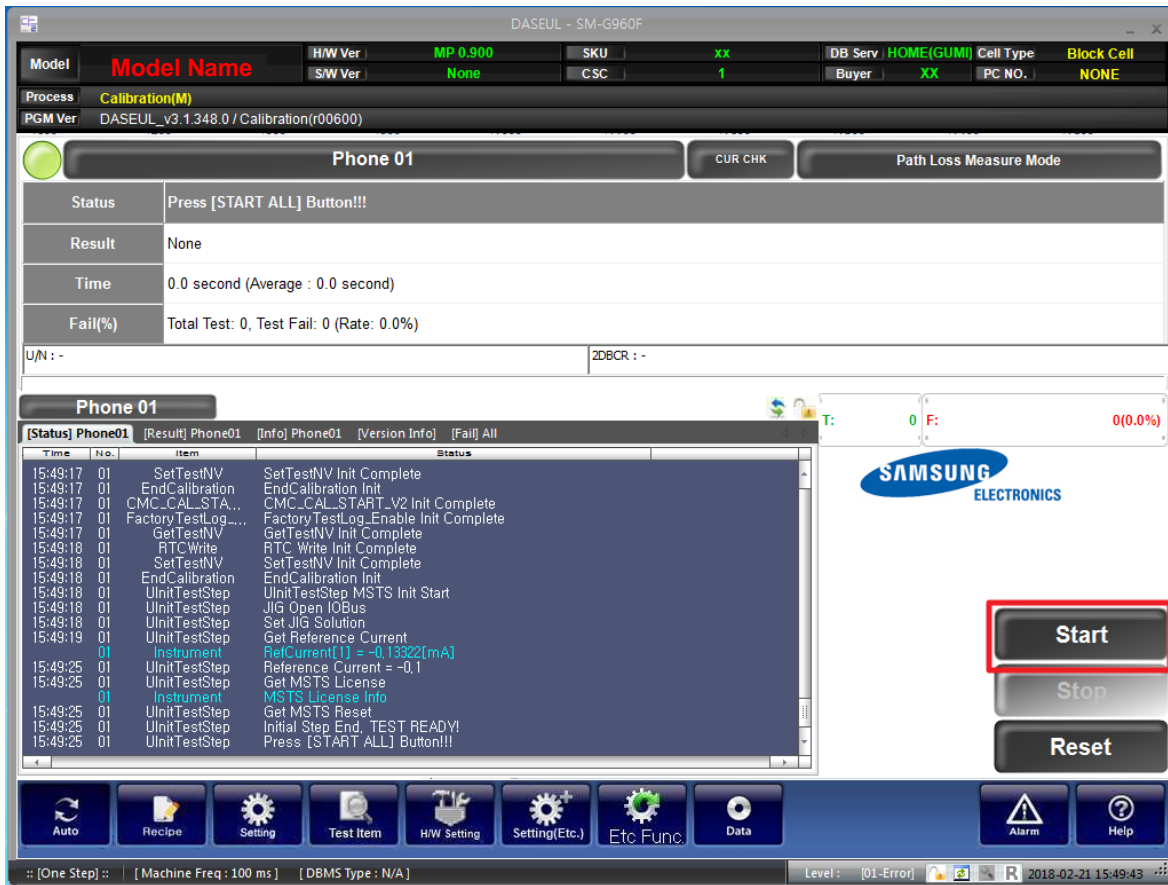
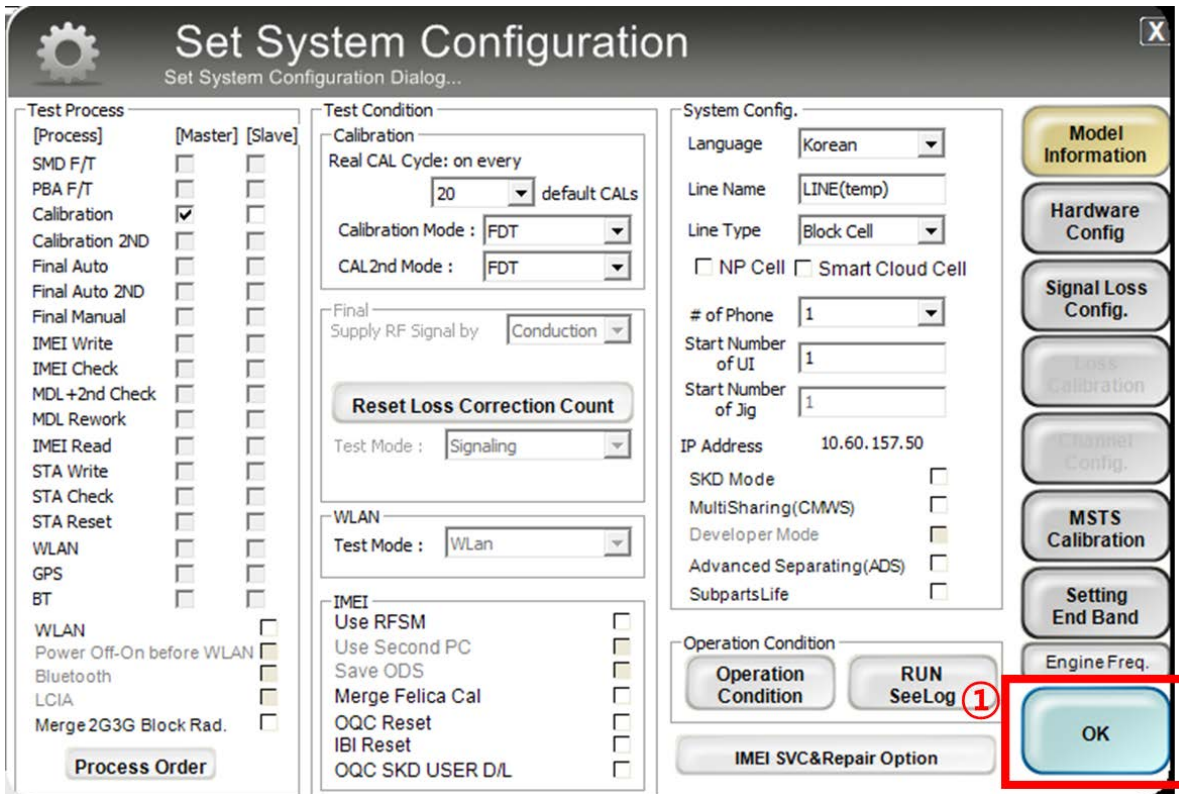

7. Level 2 Repair

7-2. Pre-requisite

	
Tweezers / Disass'y Stick / Screw Driver	Anti-static Gloves
	
Anti-static Mat	Hot Plate
	
A OCTA Disassembly Holder	OCTA Disassembly Upper
	
Ethyl Alcohol	Cotton Swab

7. Level 2 Repair

7-3. Parts which must be changed after repair

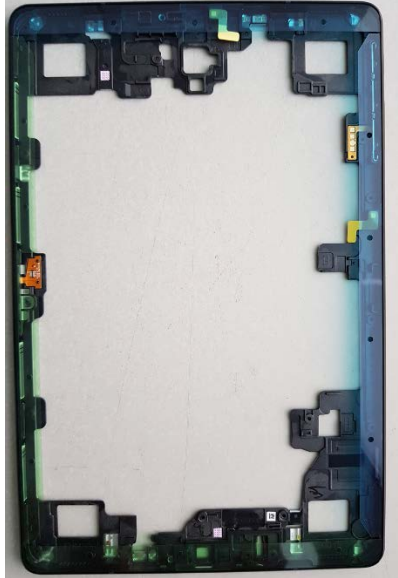
BOM Description & part code	Image	Remarks
<p>A/S Back Glass Outside Tape</p> <p>TOP, BTM, LEFT, RIGHT [GH02-16151A, GH02-16152A, GH02-16156A, GH02-16157A]</p>		<p>Replace for Back Glass repair</p>
<p>A/S Rear Outside Tape</p> <p>TOP, BTM, LEFT, RIGHT [GH02-16149A, GH02-16150A, GH02-16155A, GH02-16175A]</p>		<p>Replace for Rear repair</p>

7. Level 2 Repair

7-4. Disassembly

1

- 1) Put the device in the chamber as following below heating condition
 - SOC 68%↓: 70℃/15~20 minute
 - SOC 68%↑: 60℃/15~20 minute

※ Please confirm the heating condition released. lastly, and follow it.
- 2) When disassembly backglass, don't use alcohol.
(If use alcohol, happen window bubble effect)

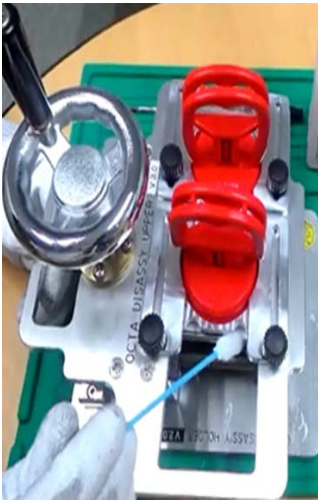

2

- Disassembly Rear[1]
1) Loosen 23ea of SCREW on rear.



※ Caution

※ Caution

3

- Disassembly Rear[2]
1) Disassembly Rear.
- Disassembly sequence : TOP -> MID -> BOT



※ Caution

4

- Loosen screws and Disassembly coaxial cable.
1) Loosen 2ea of SCREW on board.
2) Disassembly 4ea of coaxial cable.

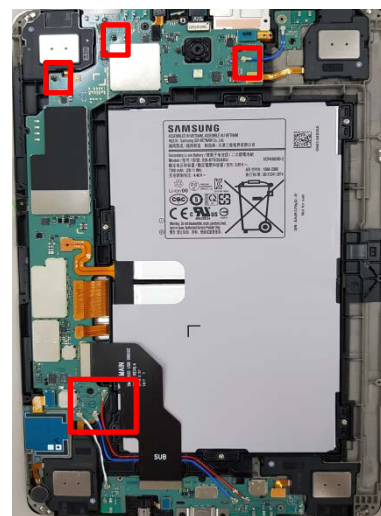

※ Caution

7. Level 2 Repair

5

Disassembly SIMSOCKET, SPK

- 1) Disassembly SIM Socket from bracket ass'y.
- 2) Disassembly Sensor Connector from PBA
- 3) Disassembly 2ea of SPK from bracket ass'y.
- 4) Disassembly OCTA and Wacom FPCB from bracket ass'y.
- 5) Disassembly IF FPCB from PBA



※ Caution

6

Disassembly battery

- 1) Loosen 8ea of SCREW around battery.
- 2) Disassembly Battery FPCB from PBA
- 3) Disassembly battery from bracket ass'y



※ Caution

7

Disassembly PBA, Earjack, SPK, USB PBA

- 1) Disassembly PBA from bracket Ass'y.
- 2) Disassembly Earjack from Bracket Ass'y.
- 3) Disassembly USB PBA from Bracket Ass'y.
- 4) Disassembly 2EA SPK from Bracket Ass'y.

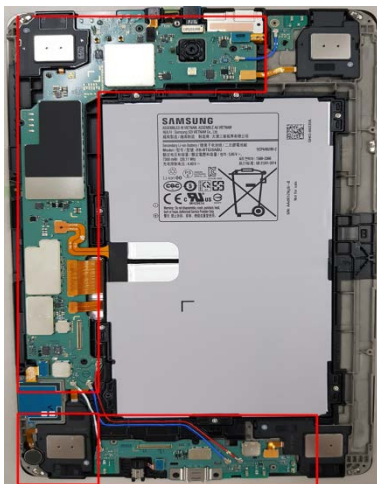

※ Caution

8

Disassembly OCTA

- 1) Disassembly OCTA using disassembly JIG.

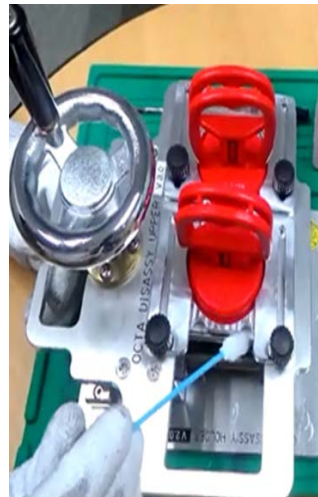

※ Caution

- 1) CHAMBER condiation : 70°C ±5°C, 15±5 minutes

7. Level 2 Repair

7-5. Assembly

1

Assembly PBA Ass'y
1) Assembly IRIS Cam, Front Camera and Main Camera on PBA.

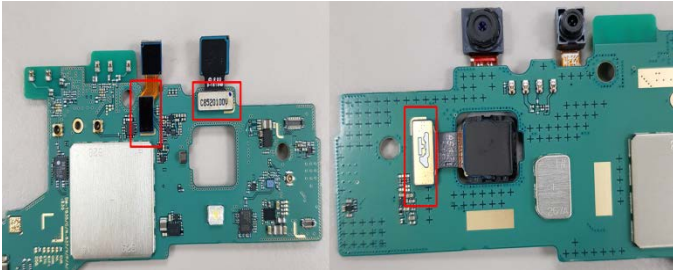

2

Assembly PBA Ass'y
1) Assembly 3ea of coaxial cables on Sub PBA
2) Assembly Ear Jack on Sub PBA
3) Attach USB SUS on USB PBA.
4) Assembly coaxial cable on Ant PBA

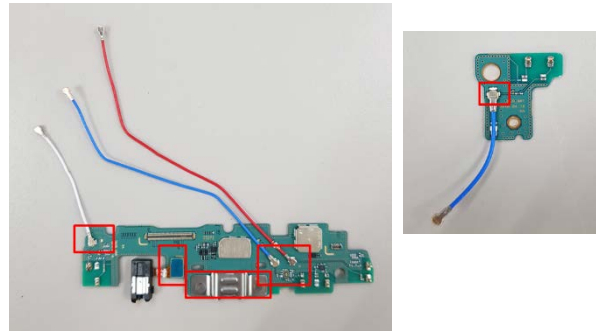

※ Caution

※ Caution

3

Assembly Bracket Ass'y [1]
1) Assemble the LCD module to bracket.
2) Assemble Battery on bracket and Fasten 8ea of screw around battery.

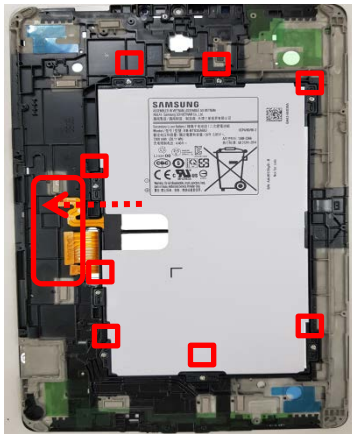

4

Assembly Bracket Ass'y[2]
1) Assembly 4ea of SPK on bracket.
(Adhesive tapes should be changed.)
2) Attach 2ea of MIC on bracket.
3) Attach SD/Sim Socket on bracket.
4) Attach Sensor FPCB on bracket.

Push Motor

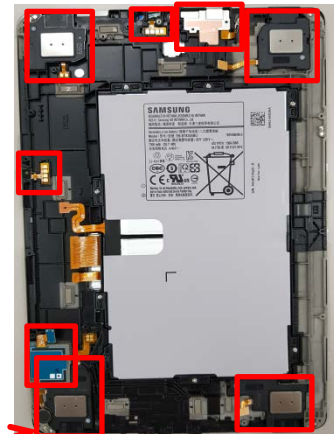

※ Caution

※ Caution

7. Level 2 Repair

5

Assembly Bracket Ass'y[3]
1) Attach Ant PBA and USB PBA on bracket.



6

Assembly USB PBA
1) Assembly PBA on bracket.
2) Attach 5ea of side contact on bracket.



※ Caution

※ Caution

7

Assembly Bracket Ass'y and PBA Ass'y[1]
1) Connect SIM Socket on PBA
2) Connect Sensor Connector on PBA
3) Connect 2ea of SPK on PBA.
4) Connect OCTA and Wacom FPCB on PBA
5) Battery Connector on PBA

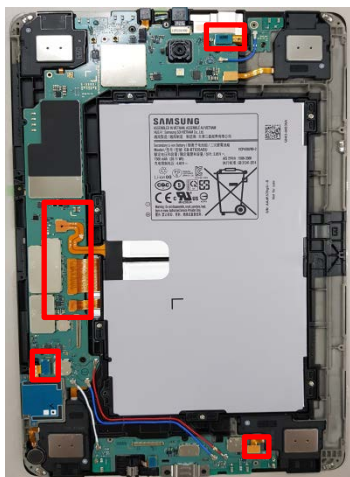

※ Caution

8

Assembly Bracket Ass'y and PBA Ass'y[2]
1) Connect 3ea coaxial cable on main board.
2) Fasten 2 ea screws on board.
3) Connect Ant PBA coaxial cable on main board.
4) Fasten a screw on Ant PBA
5) Connect IF FPCB on Main board and USB PBA.



※ Caution

7. Level 2 Repair

9

Attach the 4 new rear-outside adhesive tapes to the rear-case. (TOP, BTM, LEFT, RIGHT)

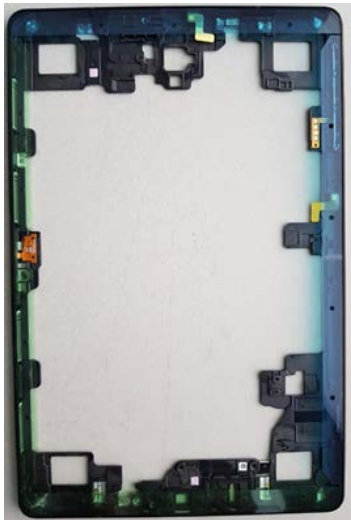

※ Caution

10

Assemble the Rear-case to the bracket.
1) Fasten 23ea of SCREW on rear.
* Torque value : 1.2kg, $\pm 7\%$



※ Caution

11

1) Attach the 4 new B/G-outside adhesive tapes to the rear-case. (TOP, BTM, LEFT, RIGHT)
2) Assemble the backglass to the rear-case.



※ Caution

12

Press the device using pressing JIG.
- Pressing force : 1 N
- Pressing time : 1 minute



※ Caution

SM-T835 Block Diagram

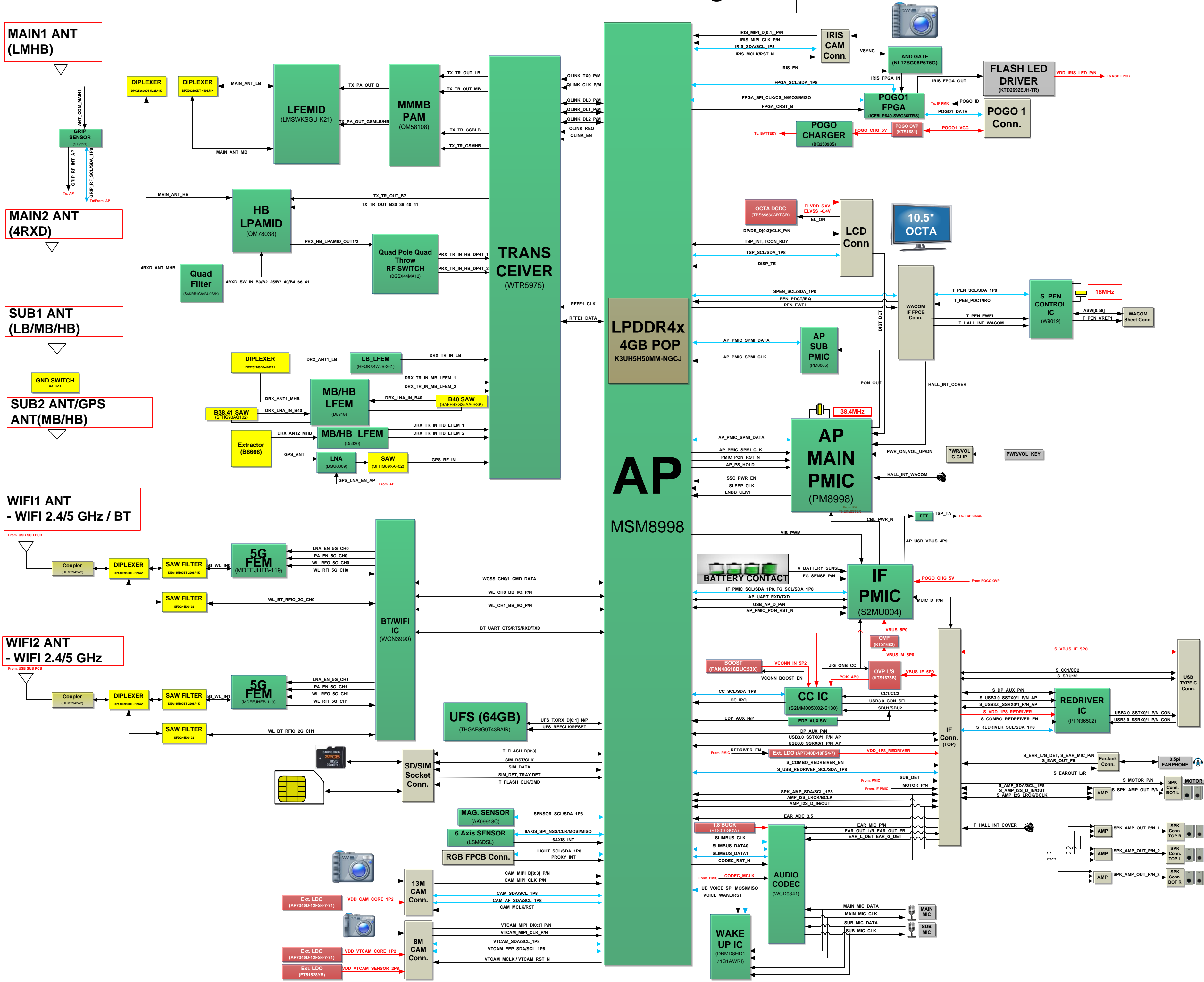

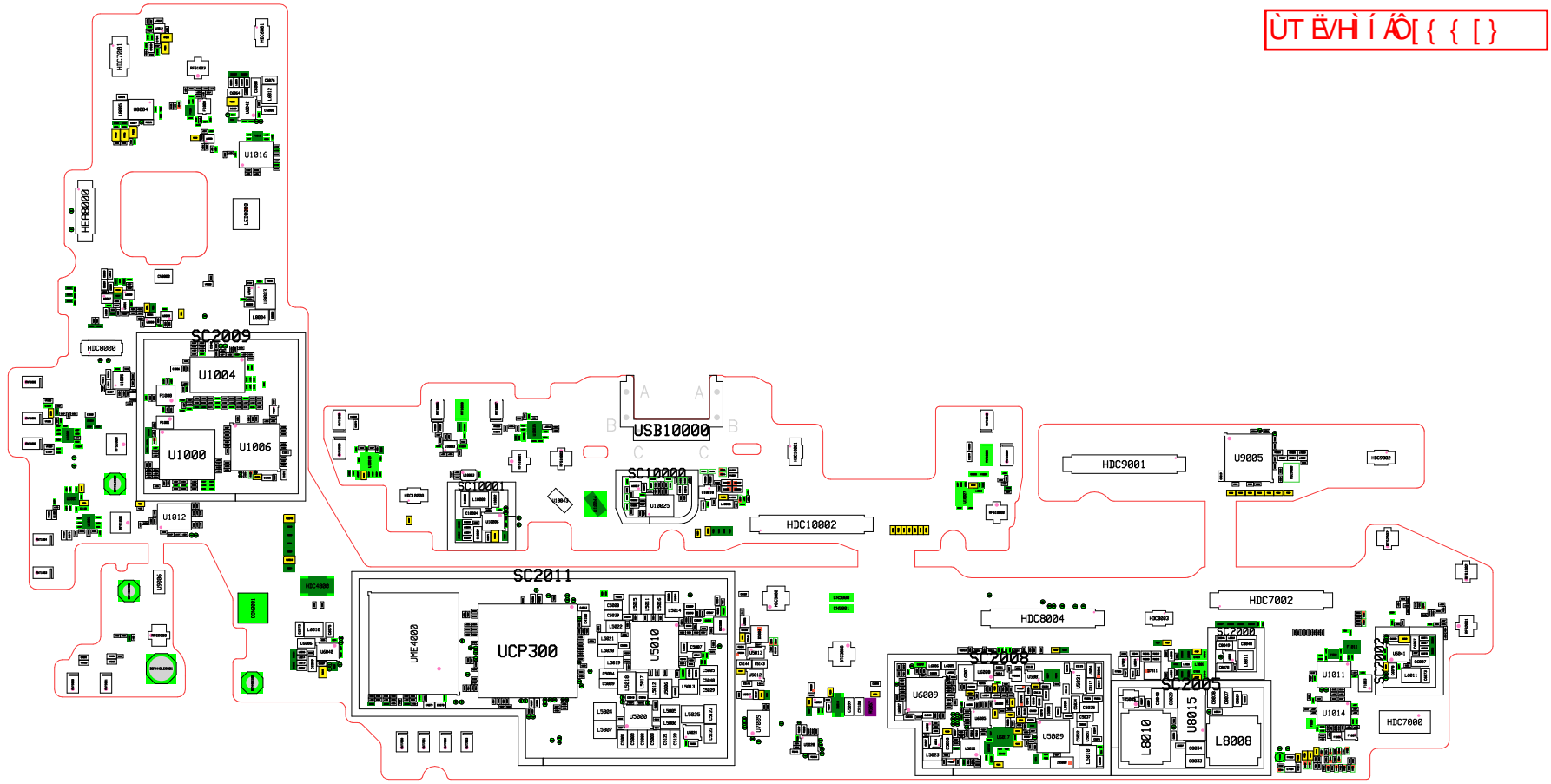

ÙT ÈVHÌ Í ÂÔ[{ { []

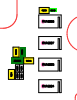
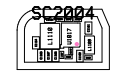
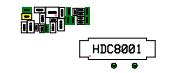
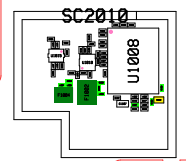
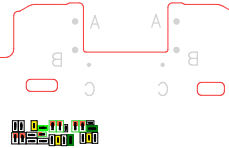
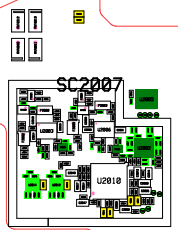

SM-T830 REV0.4 Block Diagram

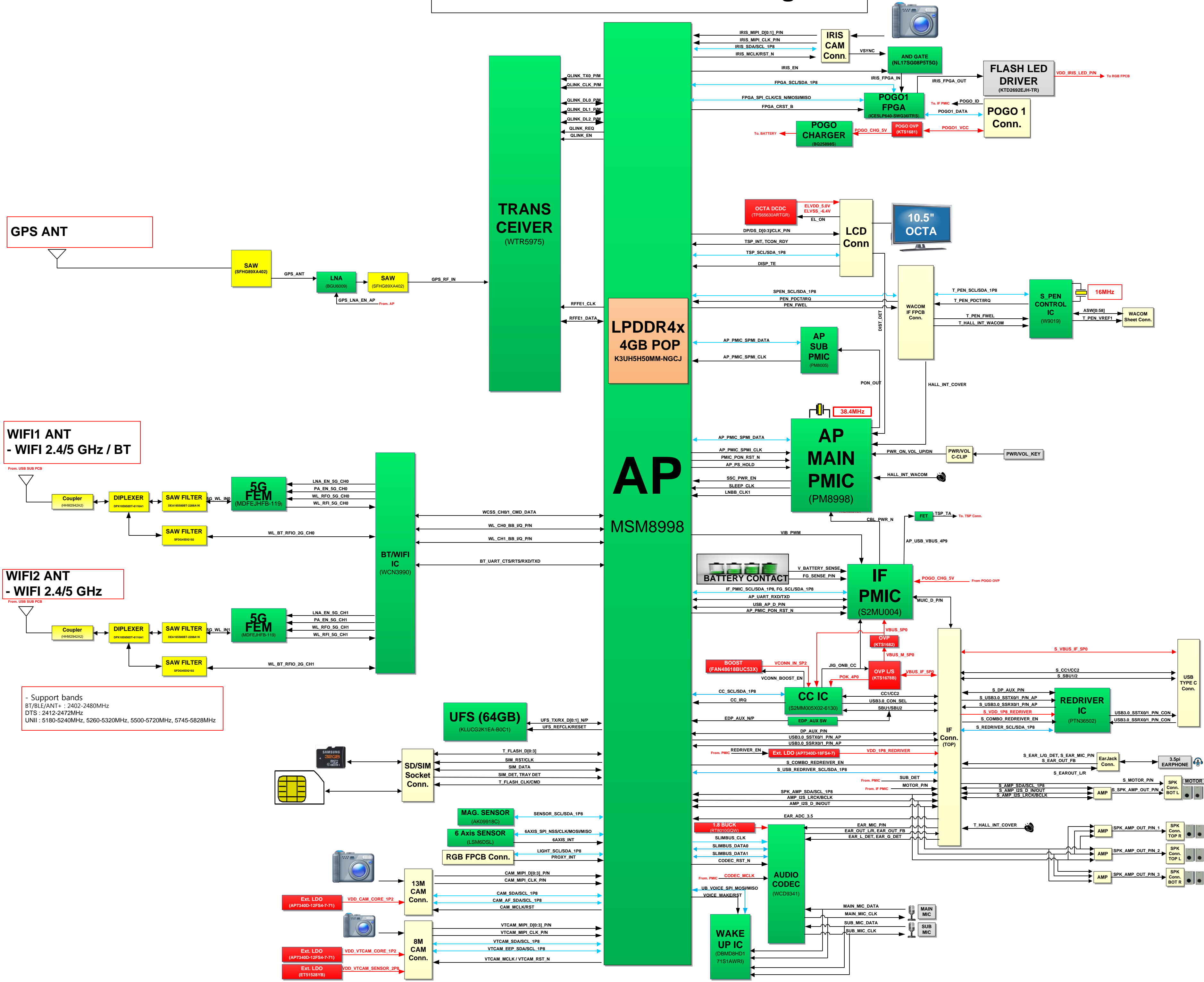

GPS ANT

WiFi1 ANT - WiFi 2.4/5 GHz / BT

WiFi2 ANT - WiFi 2.4/5 GHz

- Support bands
 BT/BLE/ANT+ : 2402-2480MHz
 DTS : 2412-2472MHz
 UNII : 5180-5240MHz, 5260-5320MHz, 5500-5720MHz, 5745-5828MHz

TRANS CEIVER (WTR5975)

AP MSM8998

LPDDR4x 4GB POP K3UH5H50MM-NGCJ

AP MAIN PMIC (PM8998)

IF PMIC (S2MU004)

UFS (64GB) (KLUUG2K1EA-B0C1)

MAG. SENSOR (AK09919C)

6 Axis SENSOR (LSM6DSL)

RGB FPCB Conn.

SD/SIM Socket Conn.

13M CAM Conn.

8M CAM Conn.

IRIS CAM Conn.

POGO1 FPGA (ICESLP640-RWG361TR)

POGO CHARGER (RO2598S)

FLASH LED DRIVER (KTD2692EJH-TR)

POGO 1 Conn.

OCTA DCDC (TPS6630ARTGR)

LCD Conn.

10.5" OCTA

S PEN CONTROL IC (W9019)

AP SUB PMIC (PM8005)

IF PMIC (S2MU004)

CC IC (S2MM005X02-6130)

AUDIO CODEC (WCD9341)

WAKE UP IC (DBMD9HD1 71S1AWR1)

BOOST (FAN48618BUC53X)

OVP (KTS1682)

OVP L/S (KTS1678B)

1.8 BUCK (RT6010CG01)

REDRIVER IC (PTN36502)

Ext. LDO (AP7340D-18FS4-7)

1.8 BUCK (RT6010CG01)

Ext. LDO (AP7340D-12FS4-7-1)

Ext. LDO (ET51528VB)

3.5pi EARPHONE

EarJack Conn.

MOTOR

SPK Conn. TOP R

SPK Conn. TOP L

SPK Conn. BOT L

SPK Conn. BOT R

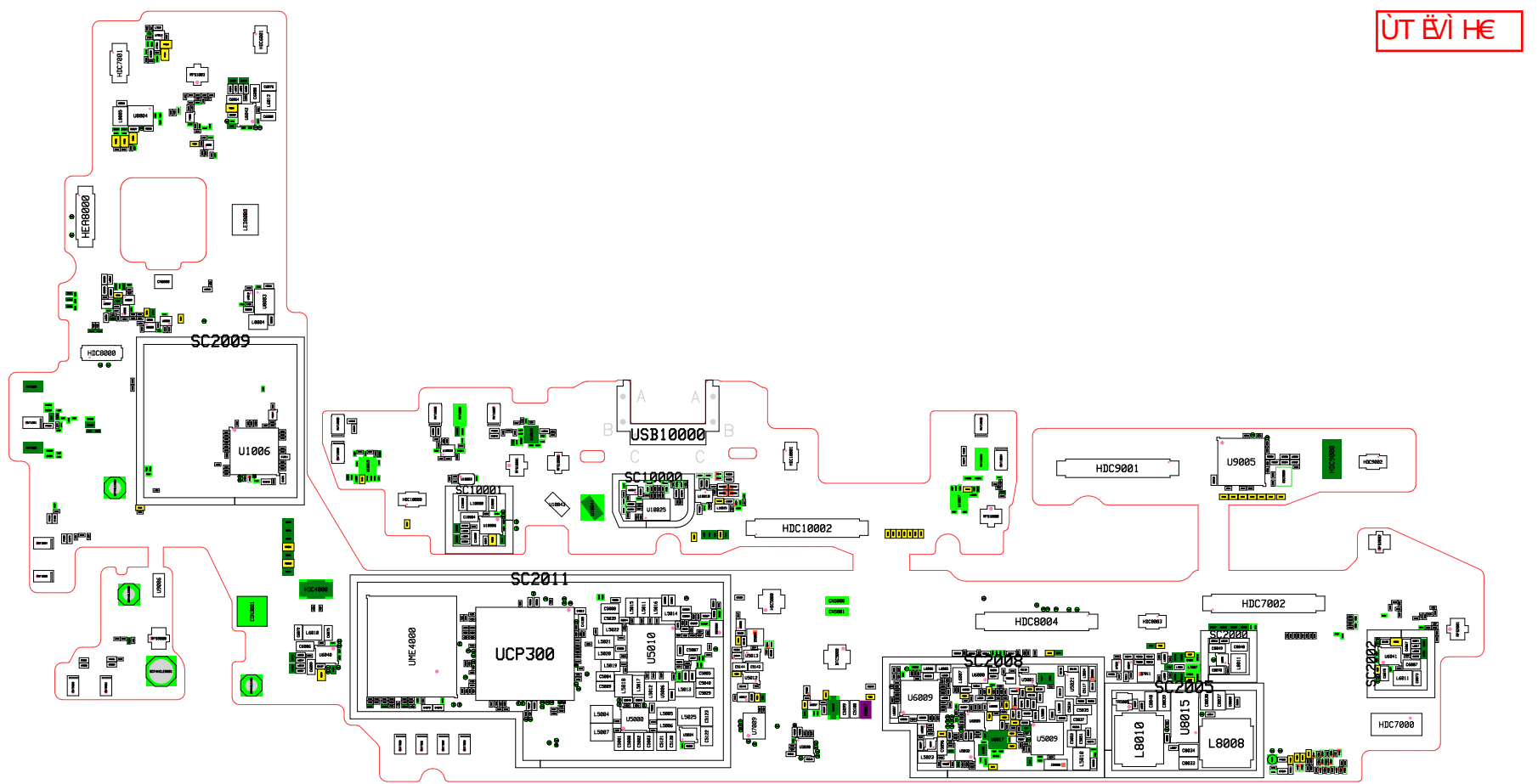

8. Level 3 Repair

8-3. Flow chart of Troubleshooting.

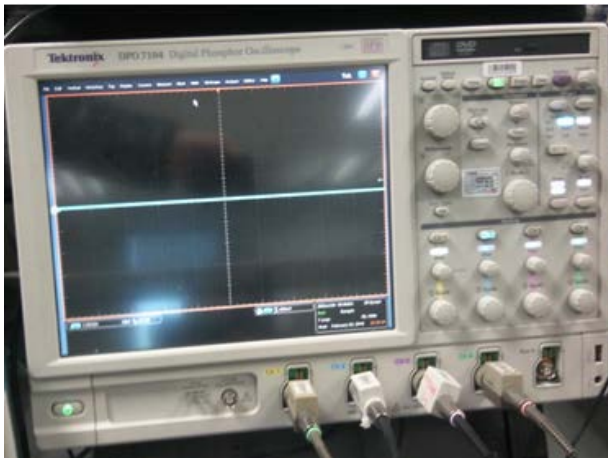

Oscilloscope



Digital Multimeter



Power Supply

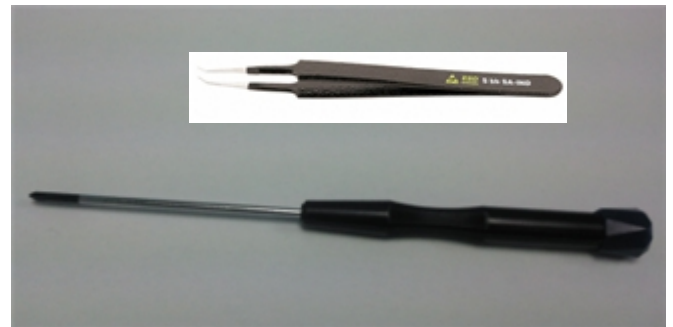

+ driver, ESD Safe Tweezer

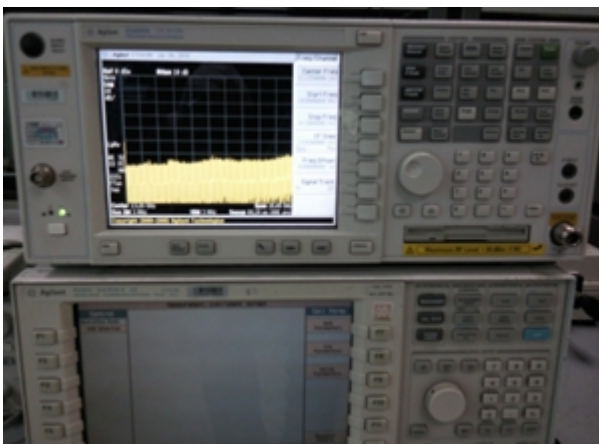

8960 & Spectrum Analyzer



Soldering iron

8. Level 3 Repair

8-4-1. Initial

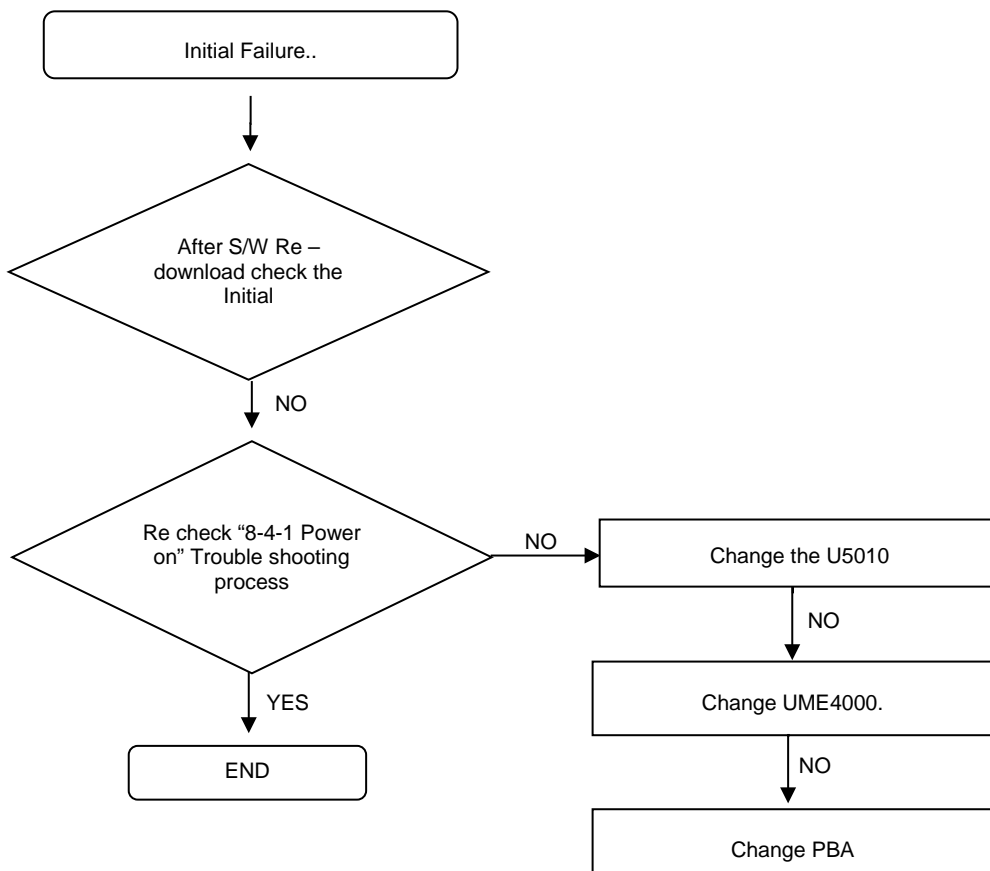

8. Level 3 Repair

8-4-2. Sim Part [SM-T835]

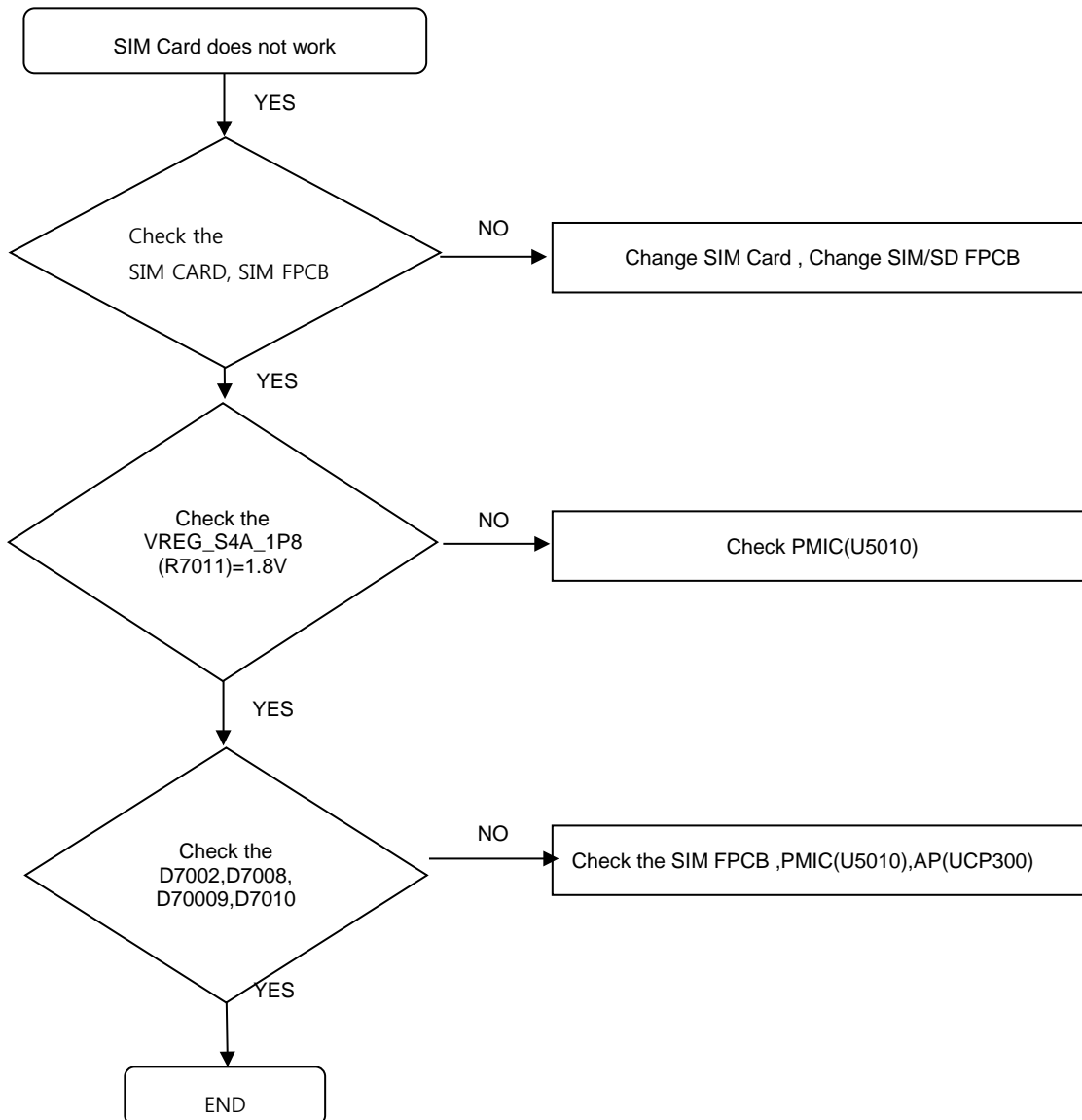

8. Level 3 Repair

8-4-3. SD PART

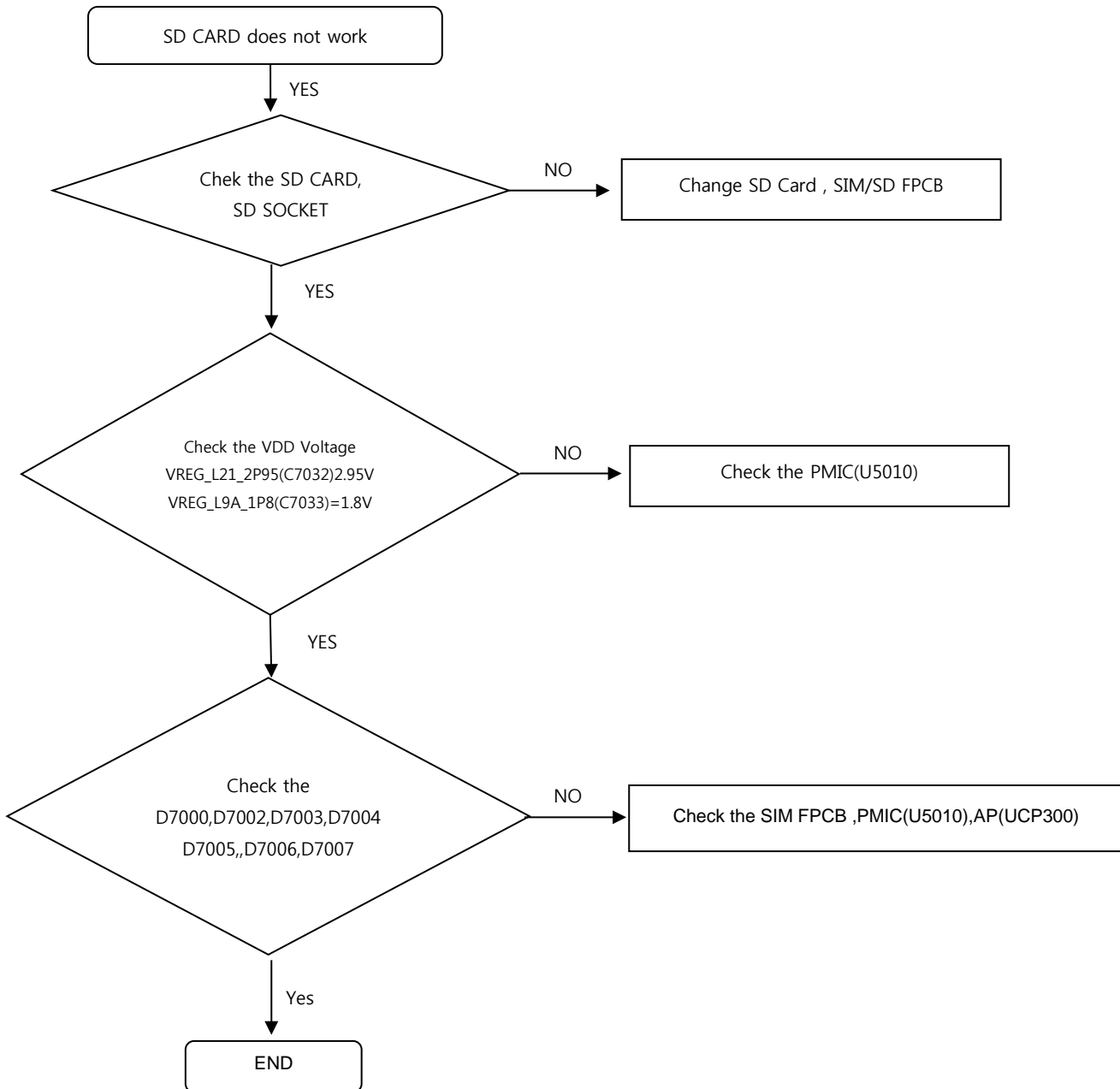

8. Level 3 Repair

8-4-4. OTG

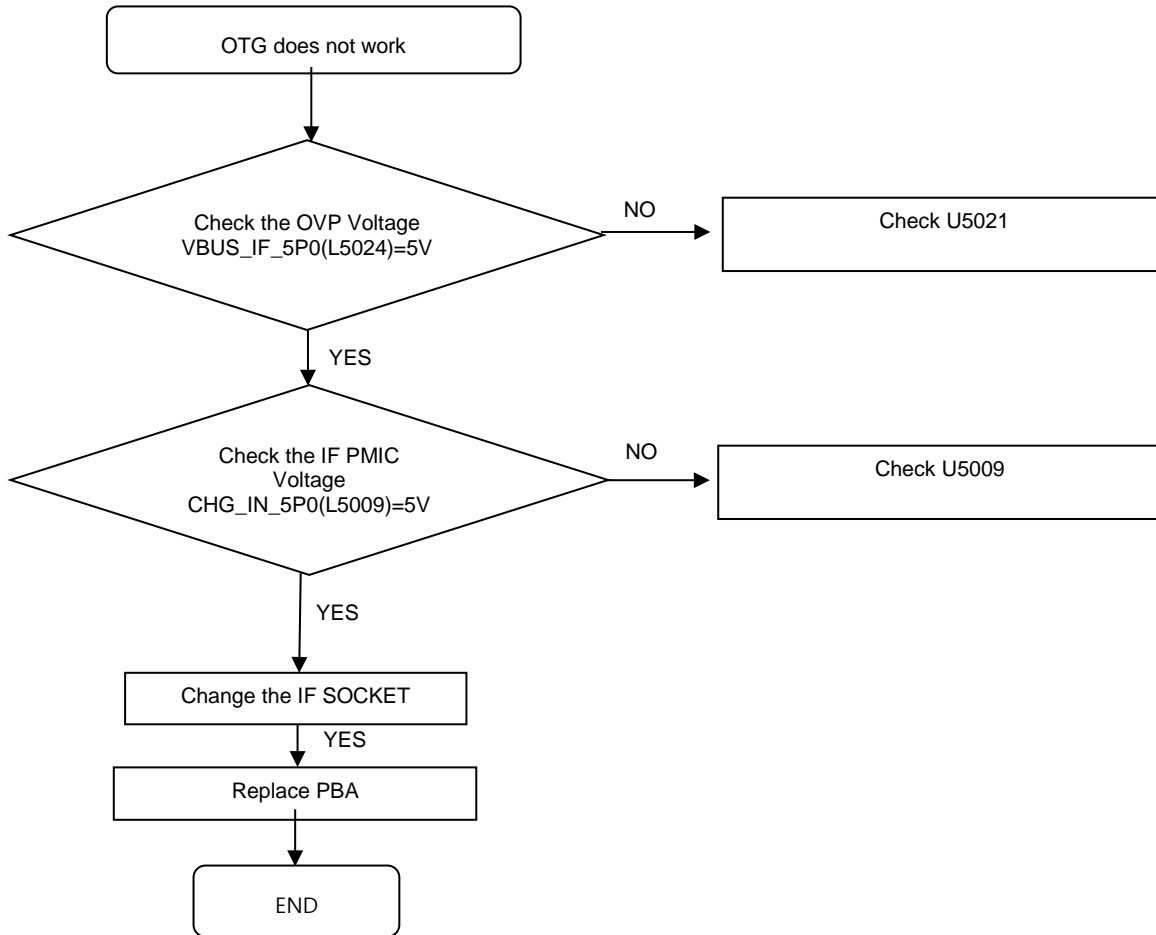

8. Level 3 Repair

8-4-5. Hall IC

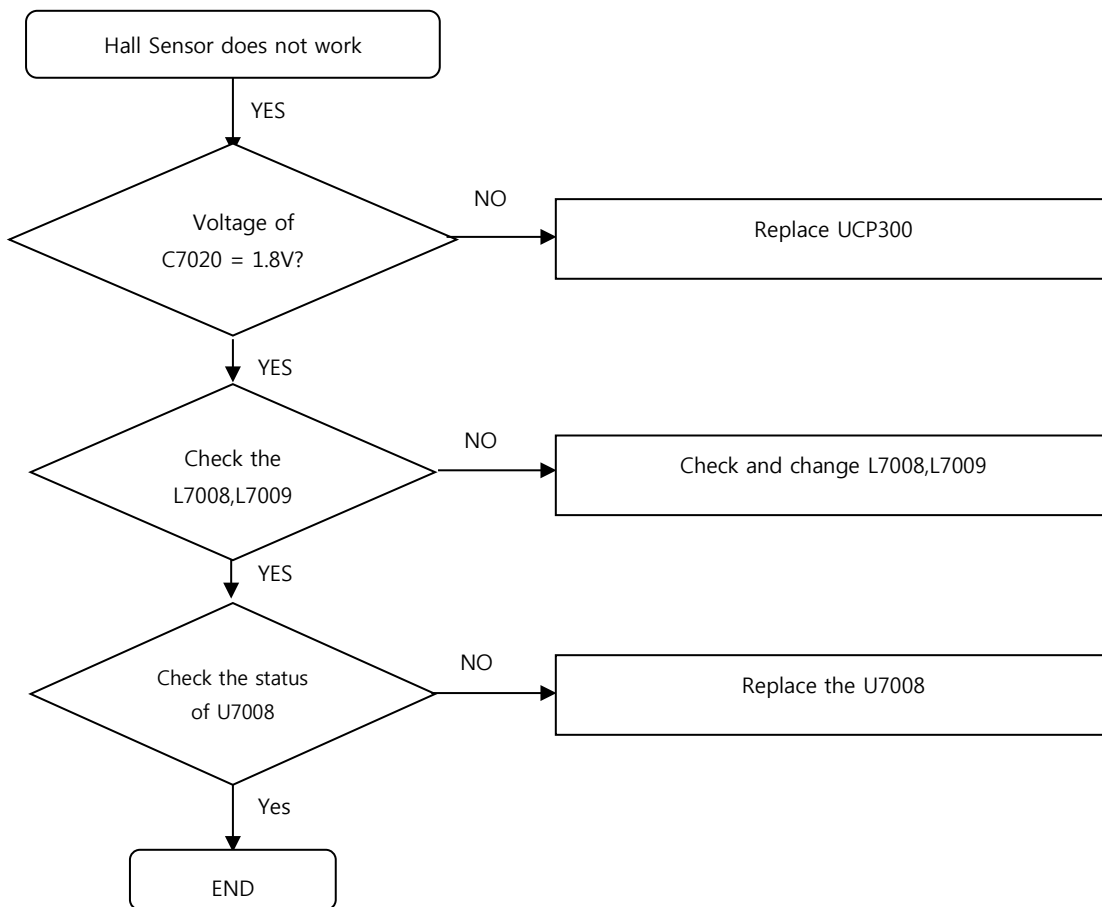

8. Level 3 Repair

8-4-6. Axis sensor

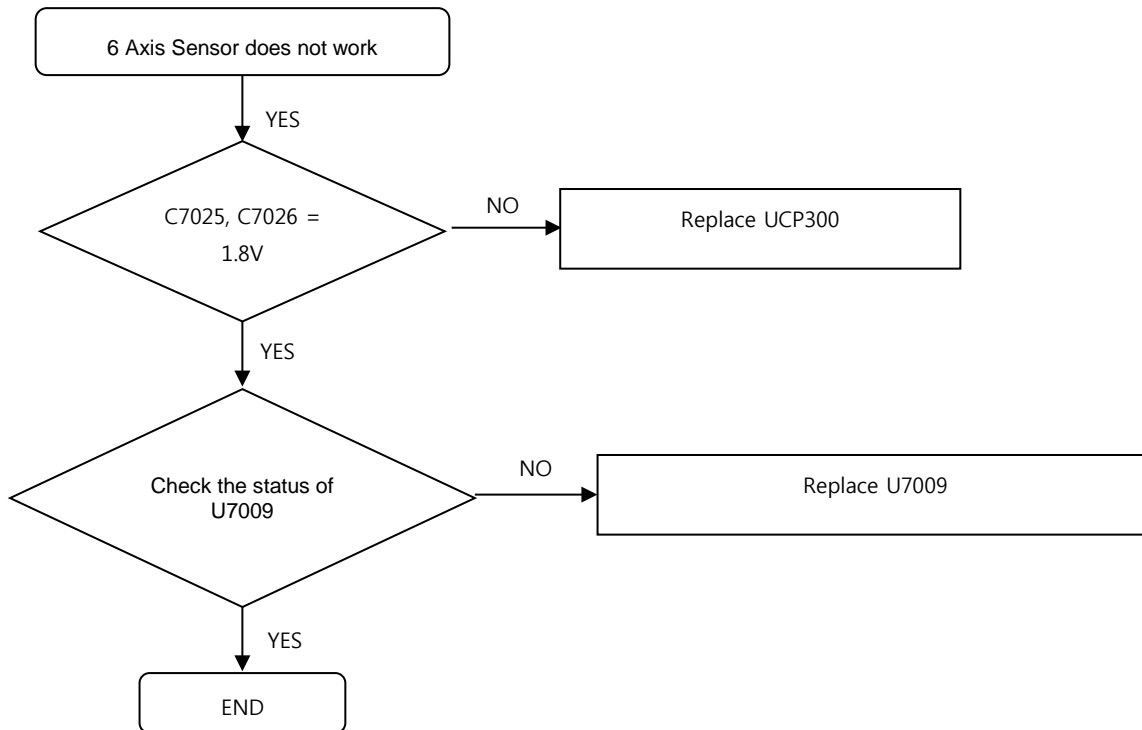

8. Level 3 Repair

8-4-7. RGB sensor

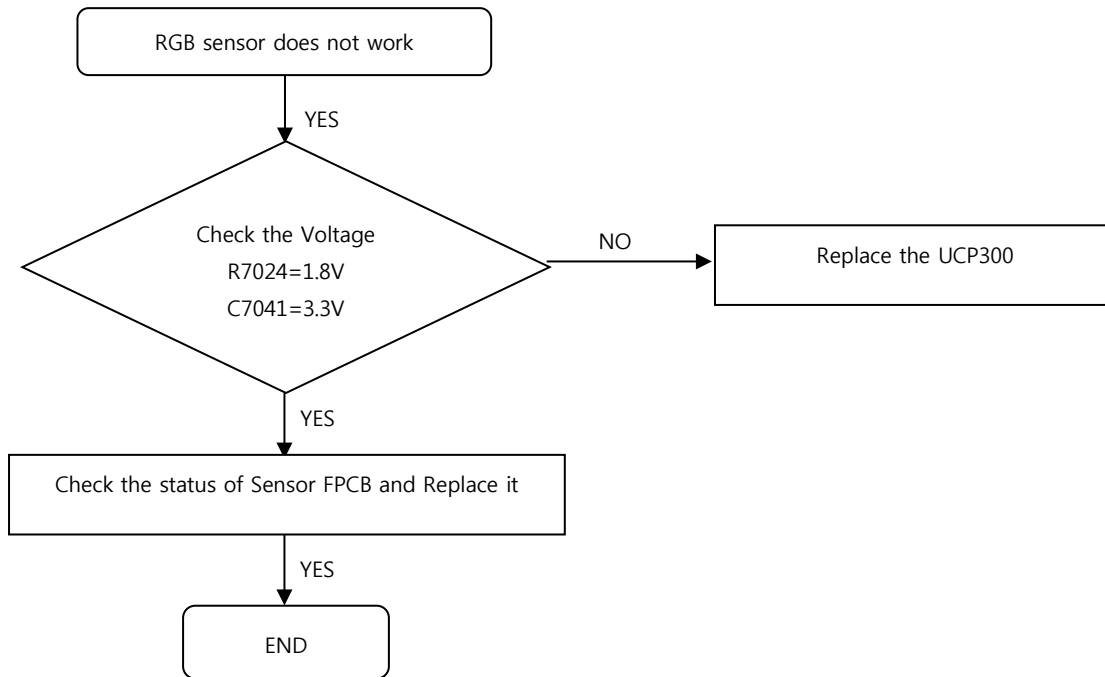

8. Level 3 Repair

8-4-8. Magnetic Sensor

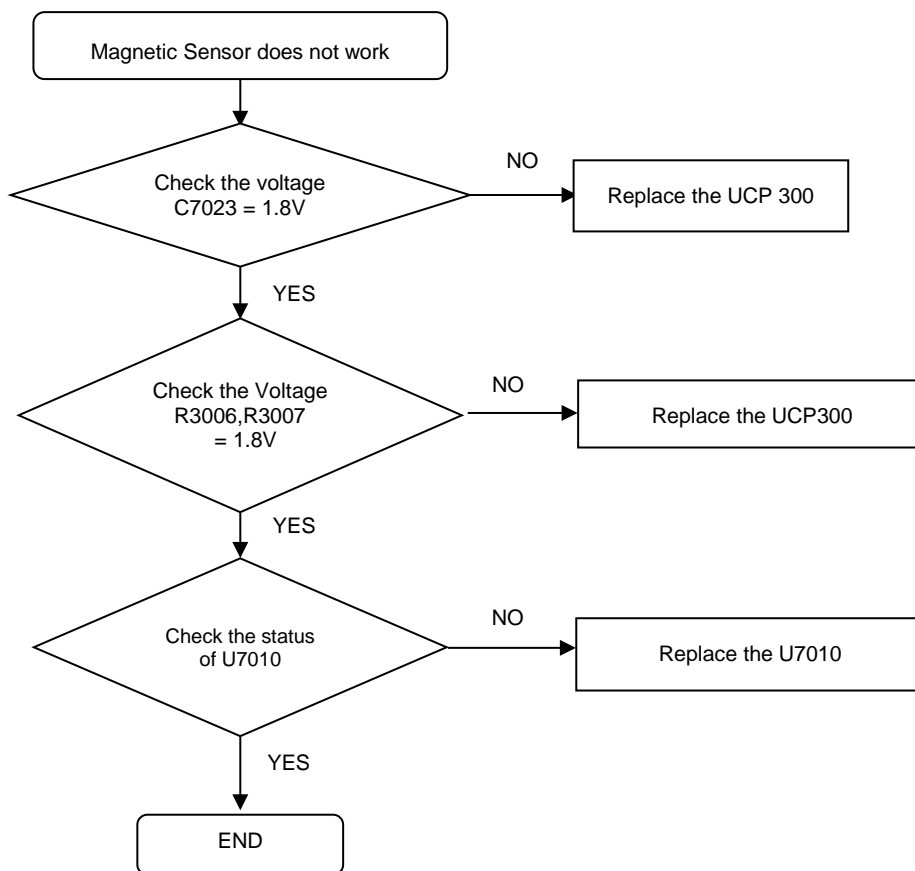

8. Level 3 Repair

8-4-9. Motor

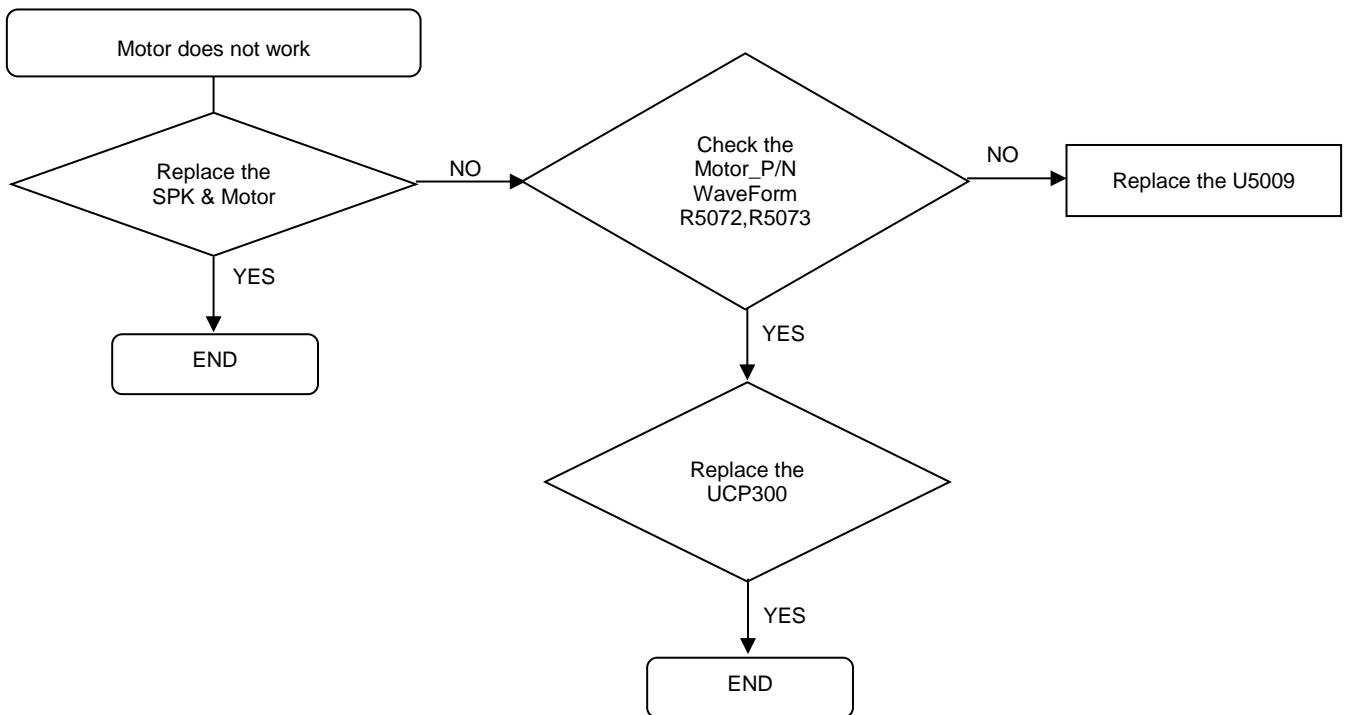

8. Level 3 Repair

8-4-10. Power On

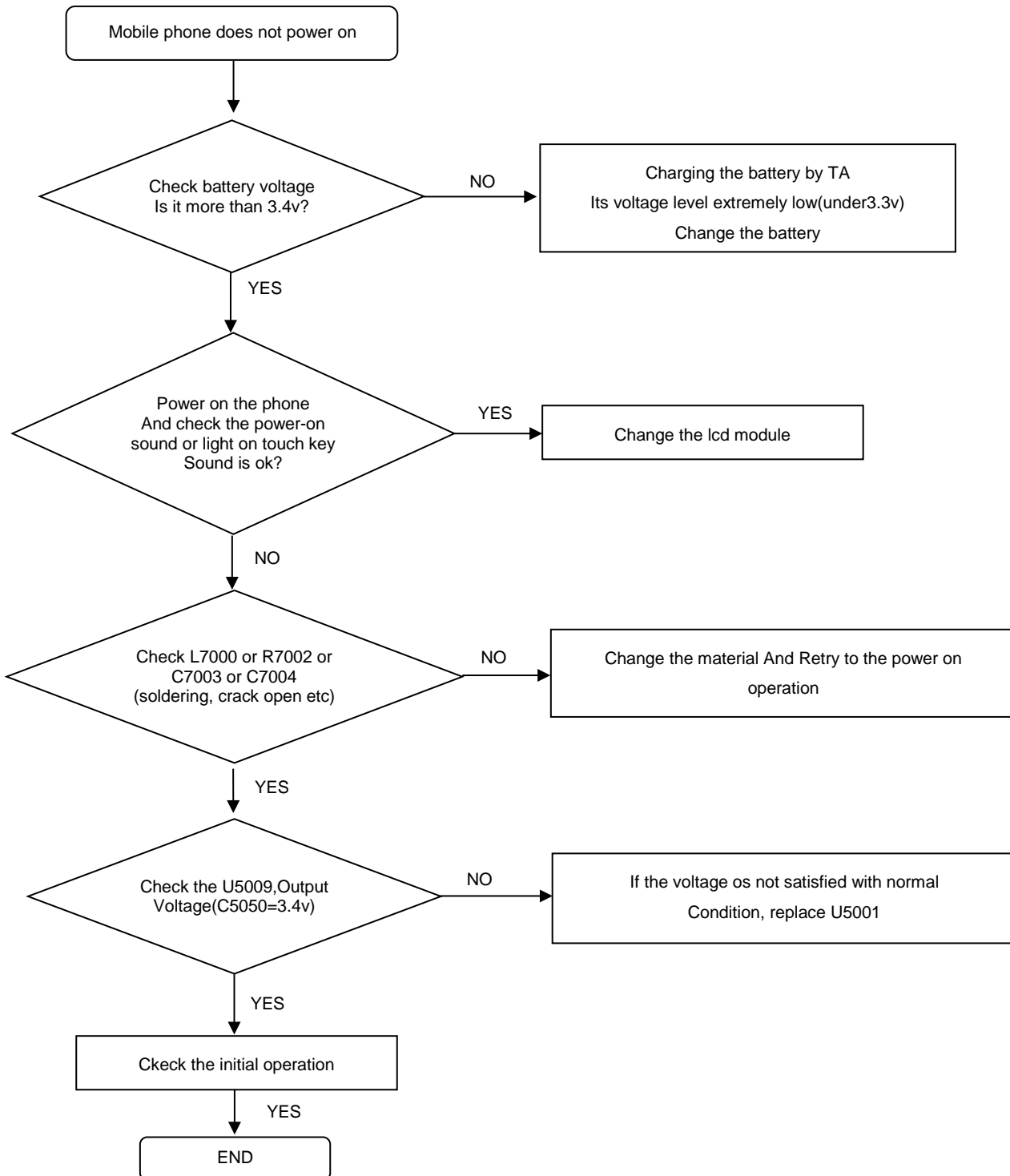

8. Level 3 Repair

8-4-11. Charging Part

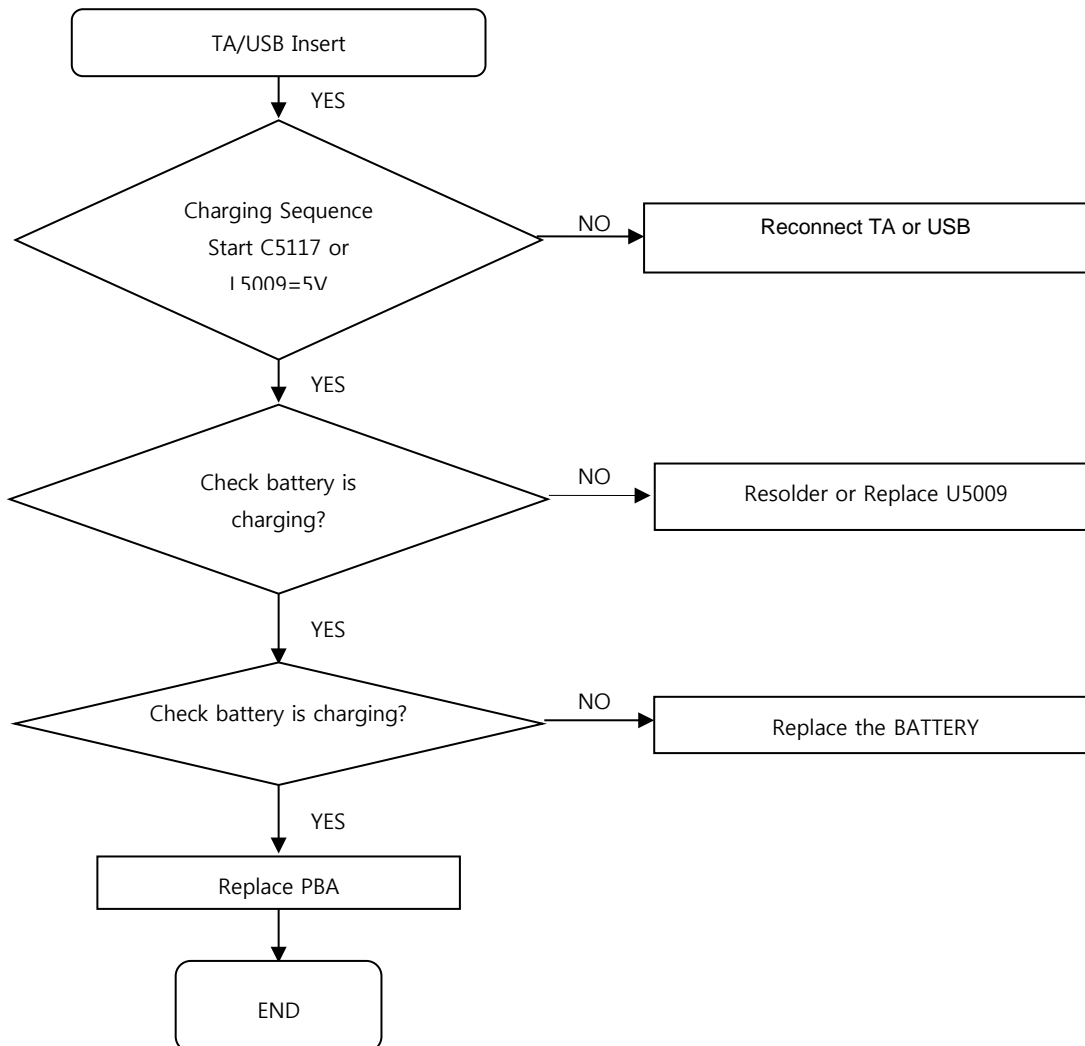

8. Level 3 Repair

8-4-12. OCTA_S-OLED

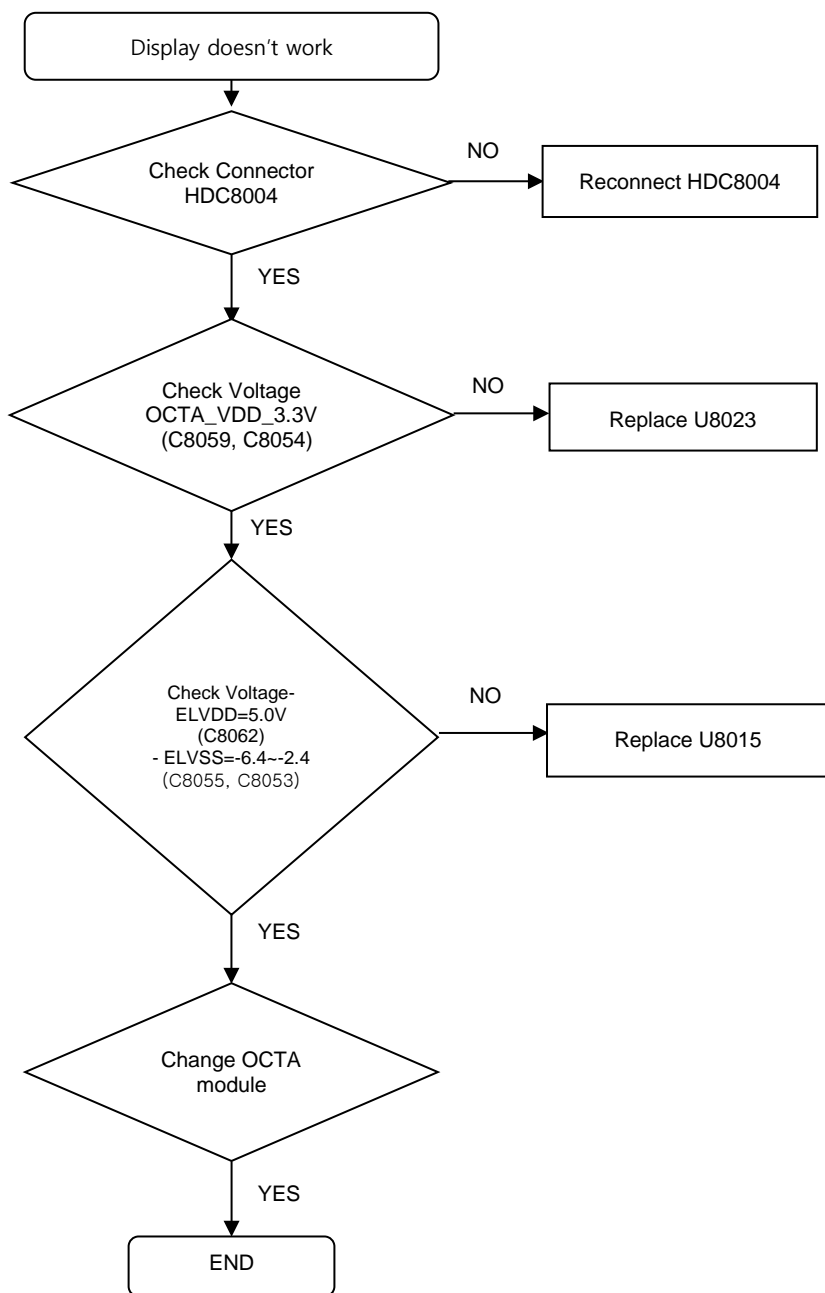

8. Level 3 Repair

8-4-13. OCTA_TSP

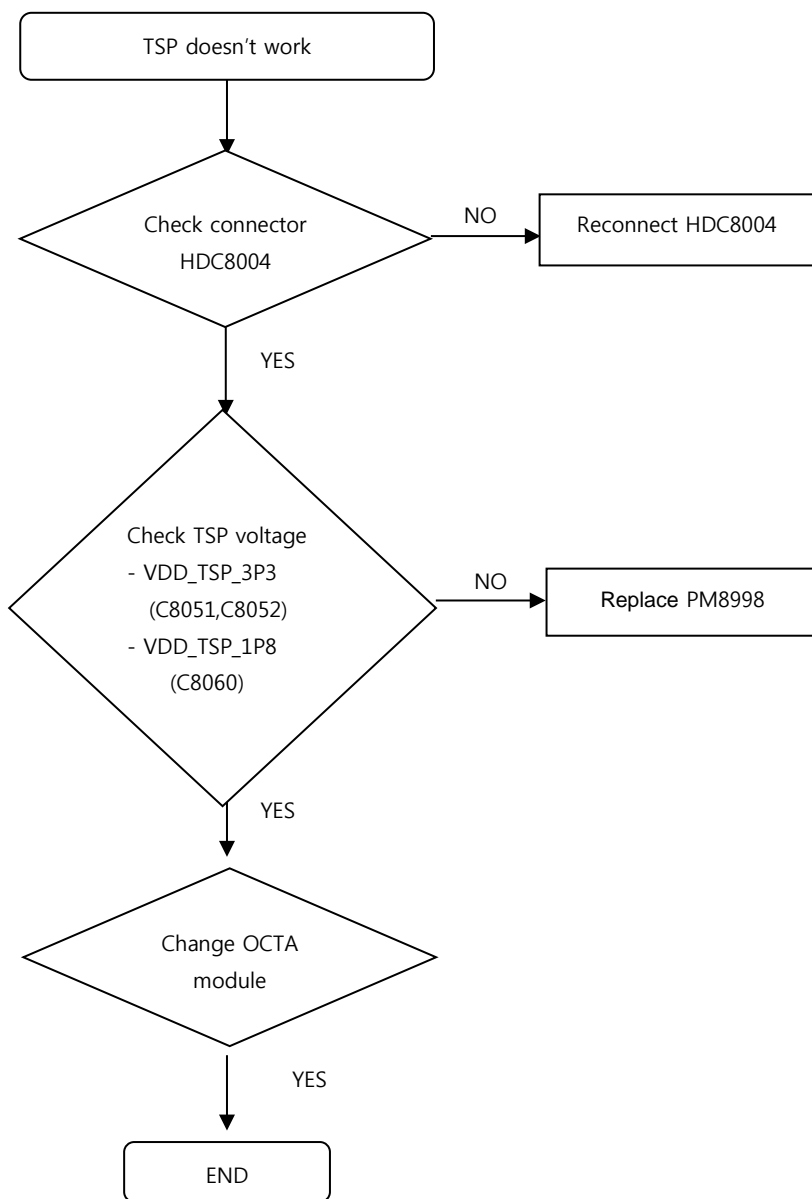

8. Level 3 Repair

8-4-14. 13M CAM

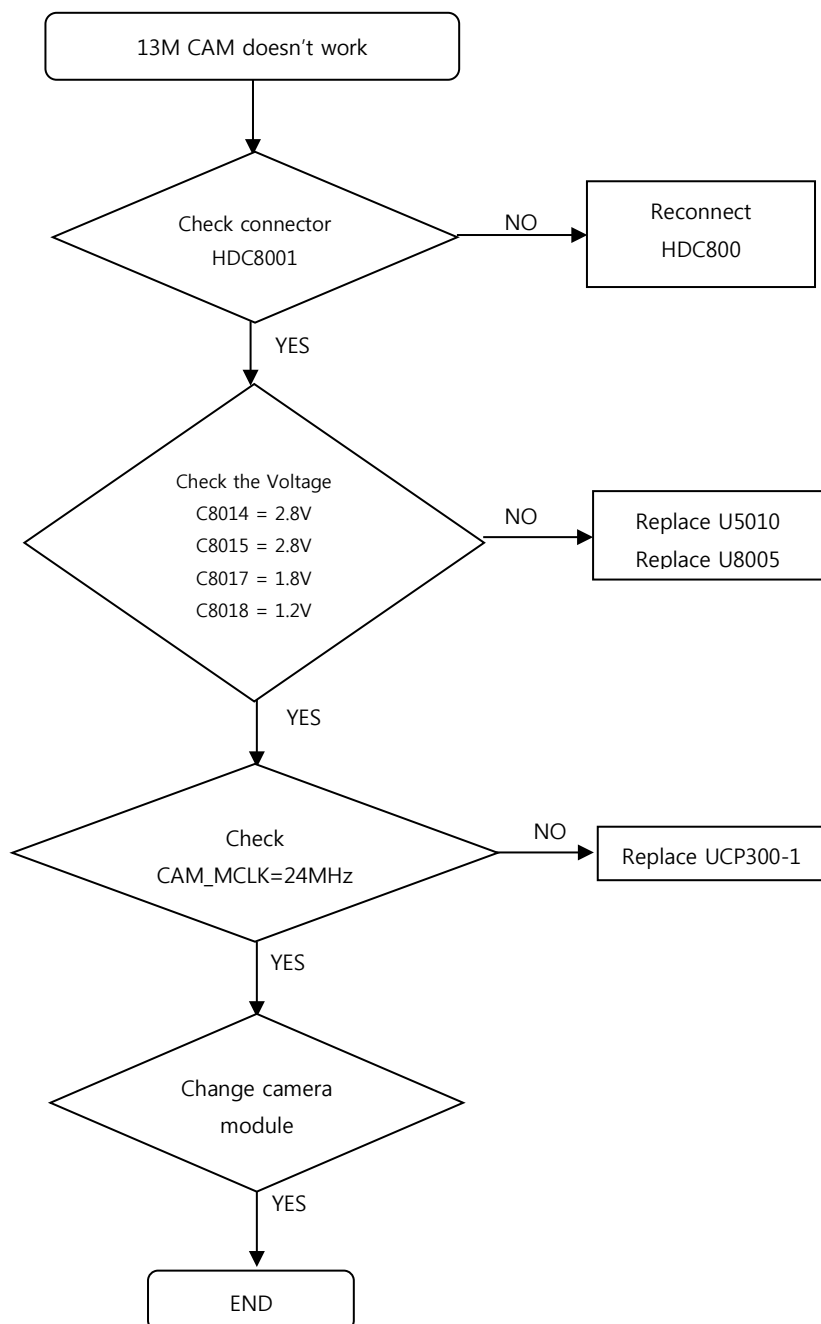

8. Level 3 Repair

8-4-15-1. 8M CAM

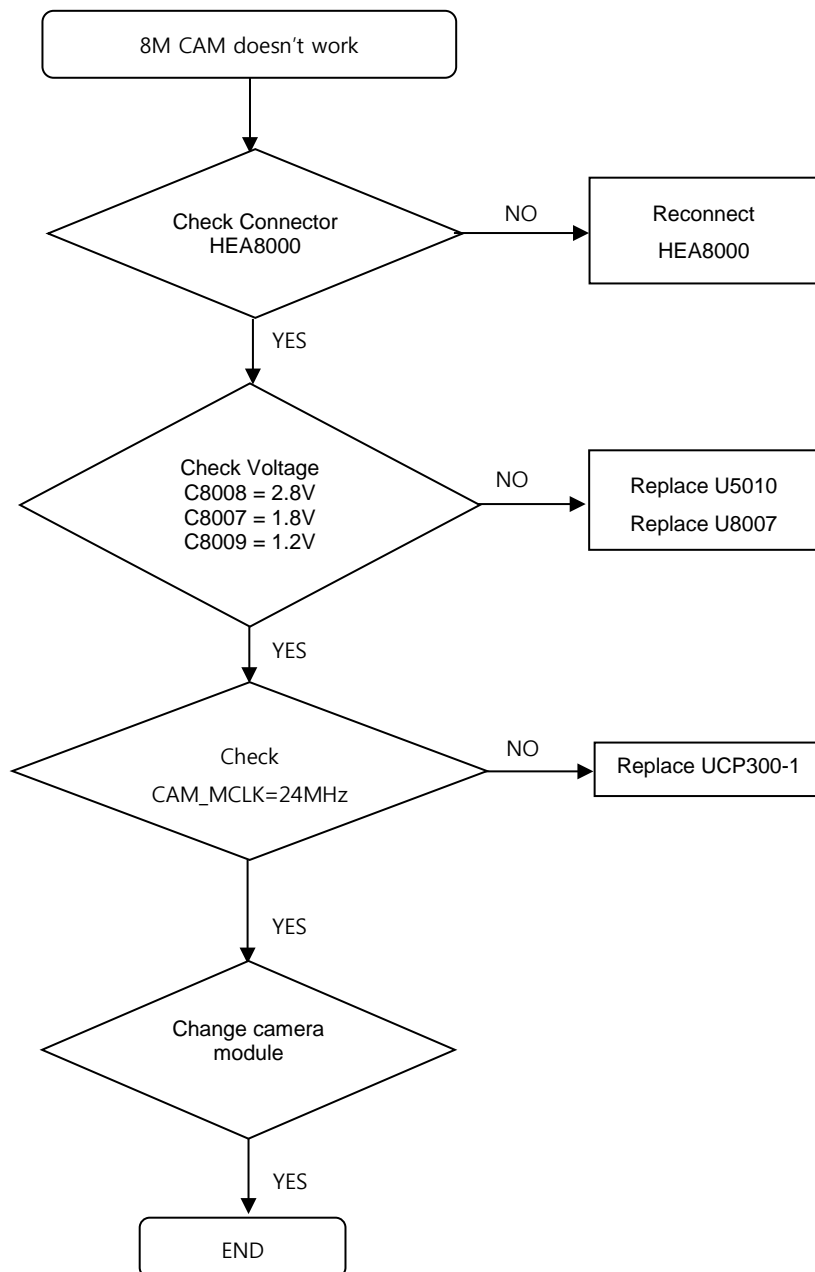

8. Level 3 Repair

8-4-15-2. IRIS CAM

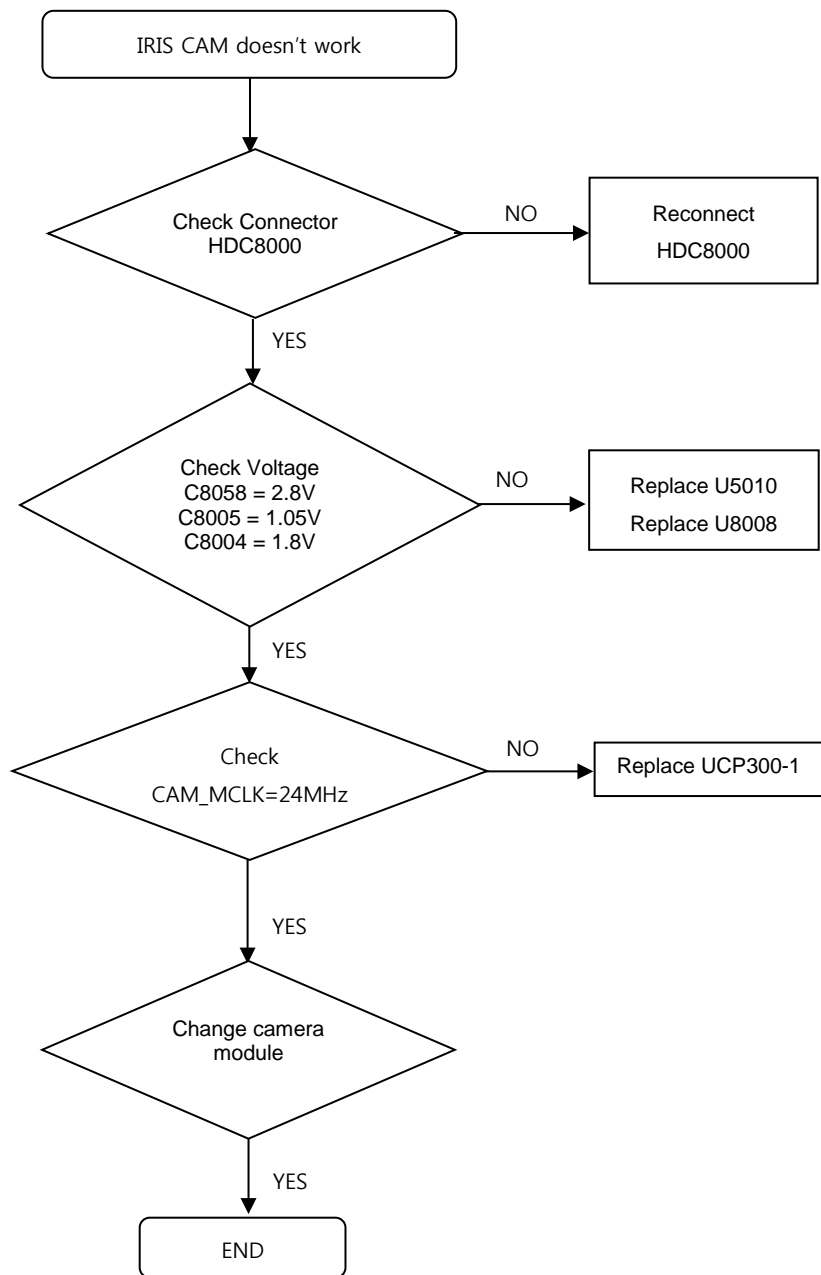

8. Level 3 Repair

8-4-16. WACOM

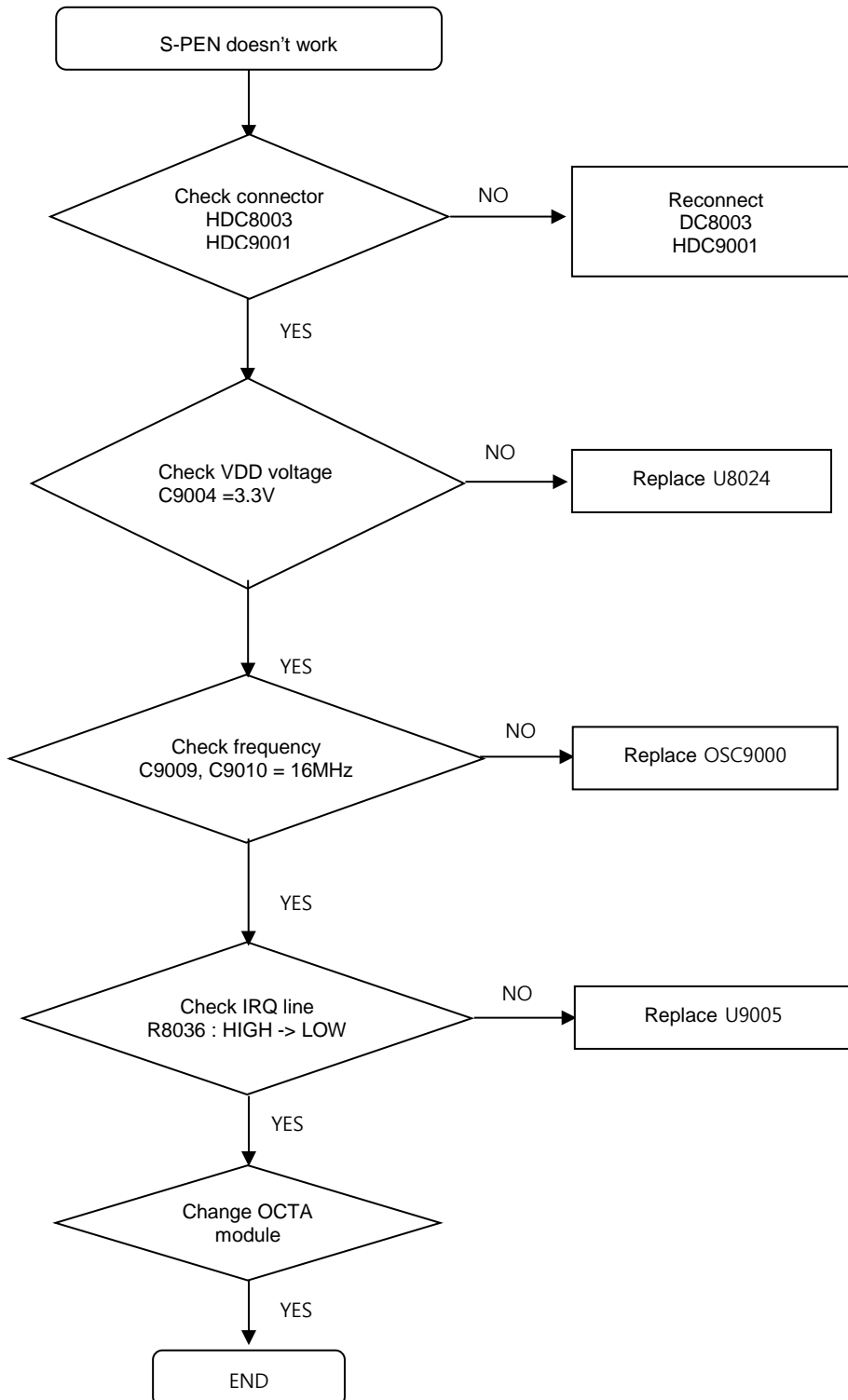

8. Level 3 Repair

8-4-17. Microphone Part - Main MIC

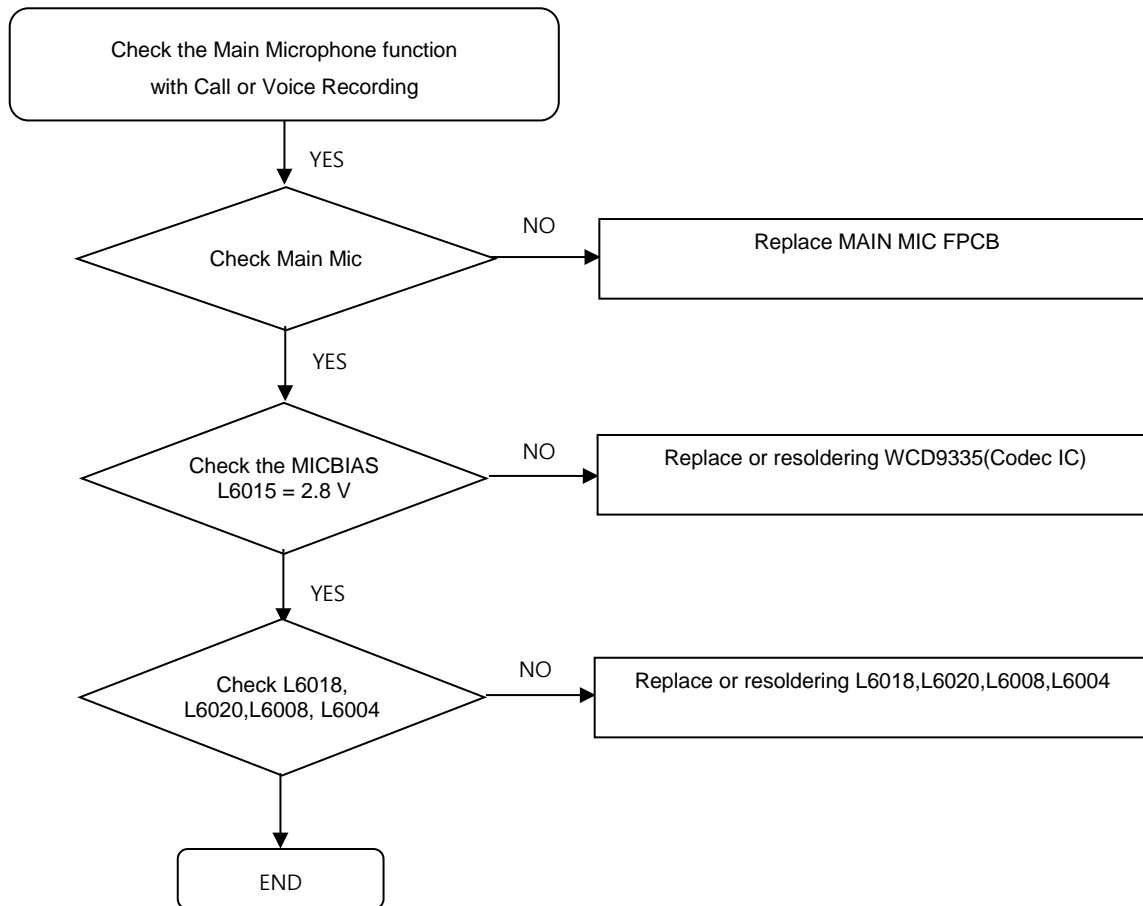

8. Level 3 Repair

8-4-18. Microphone Part - Sub MIC

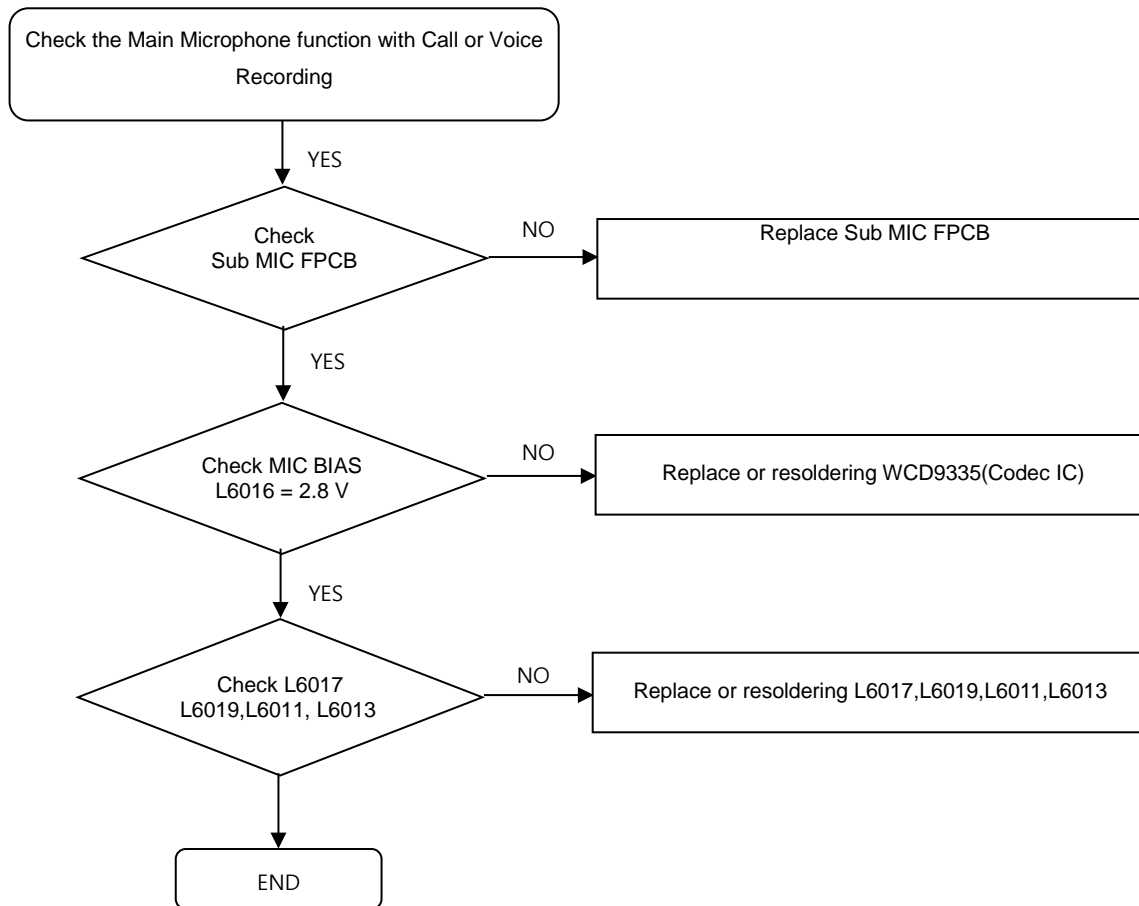

8. Level 3 Repair

8-4-19. Speaker Part – Right Upper Speaker Module

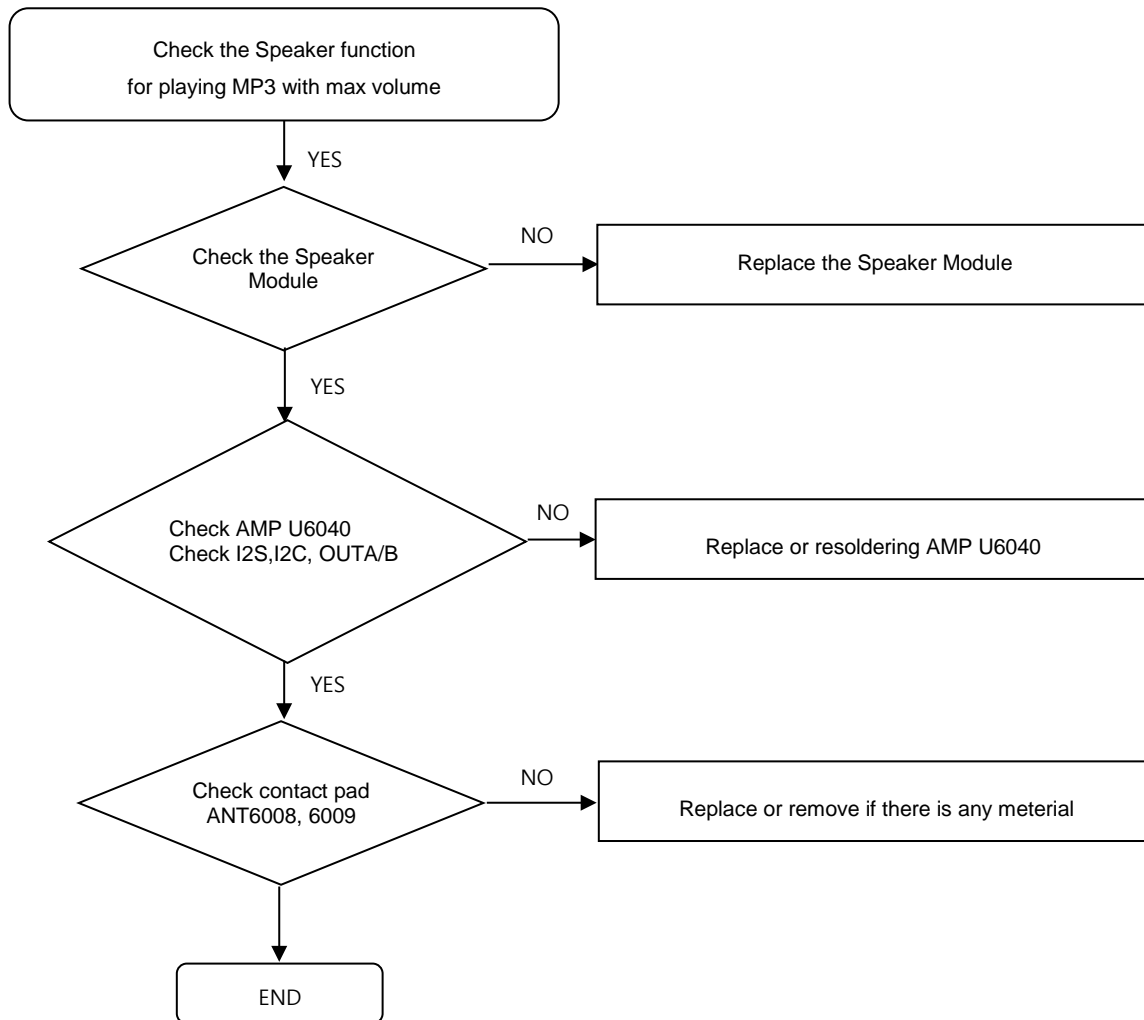

8. Level 3 Repair

8-4-20. Speaker Part – Left Upper Speaker Module

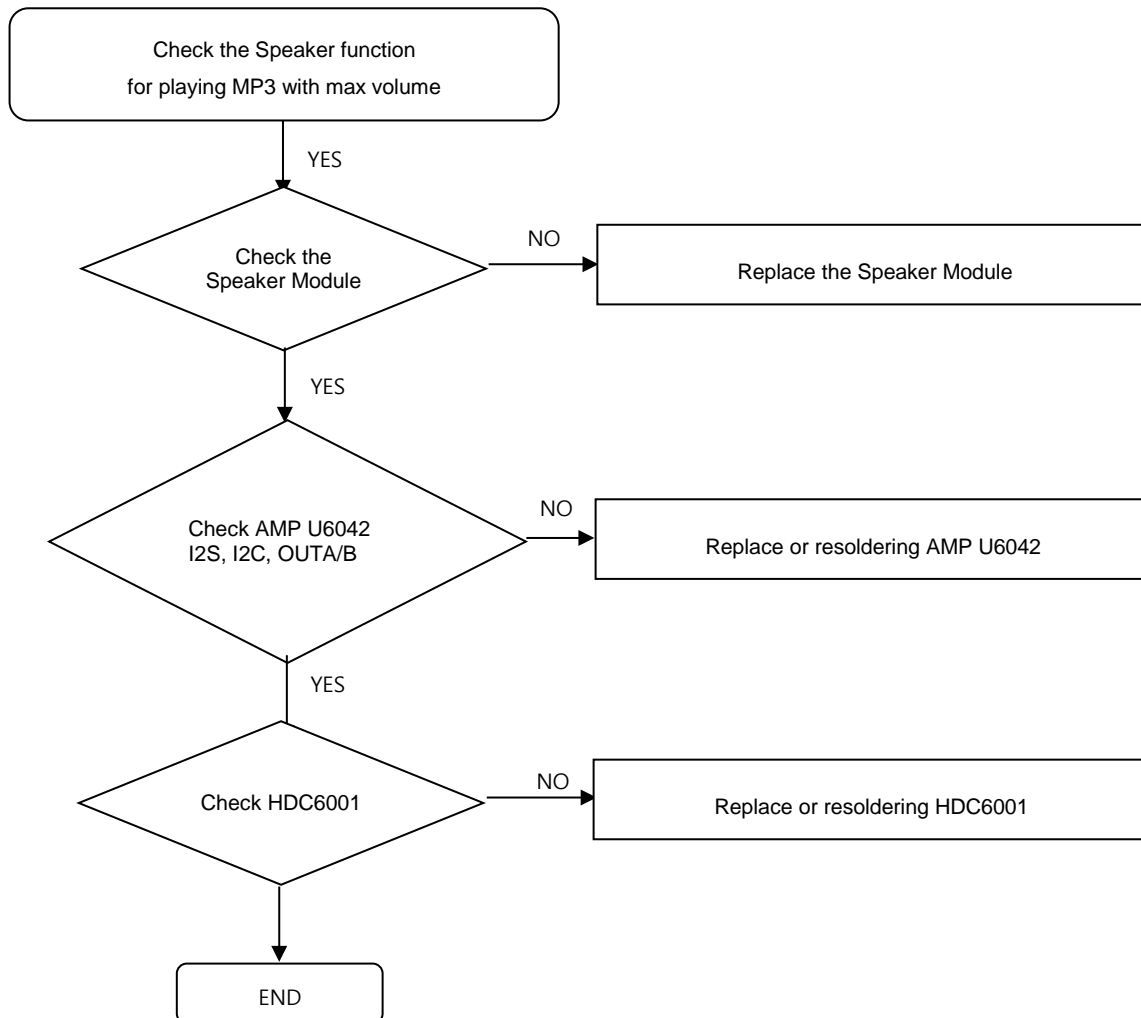

8. Level 3 Repair

8-4-21. Speaker Part – Right Lower Speaker Module

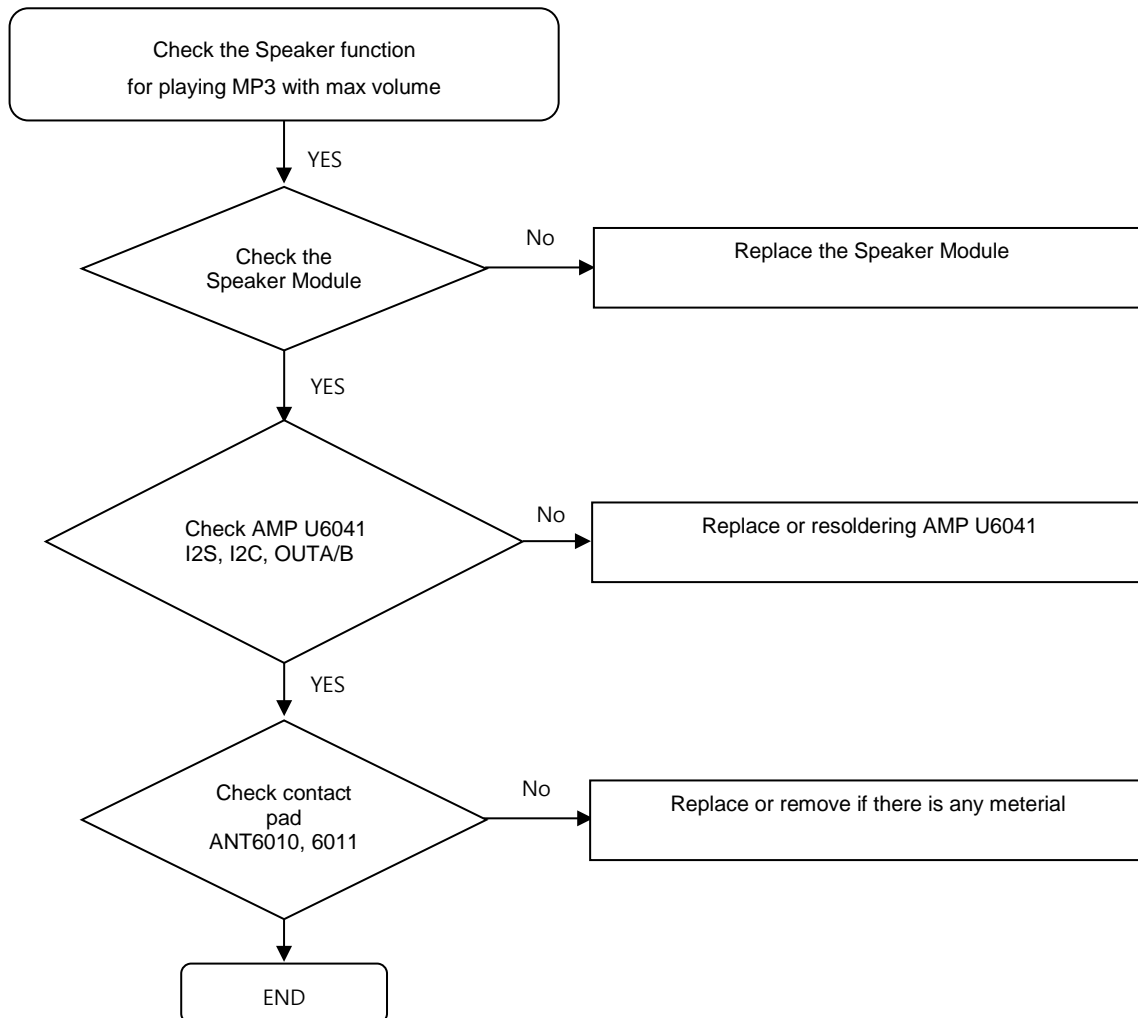

8. Level 3 Repair

8-4-22. Speaker Part – Left Lower Speaker Module

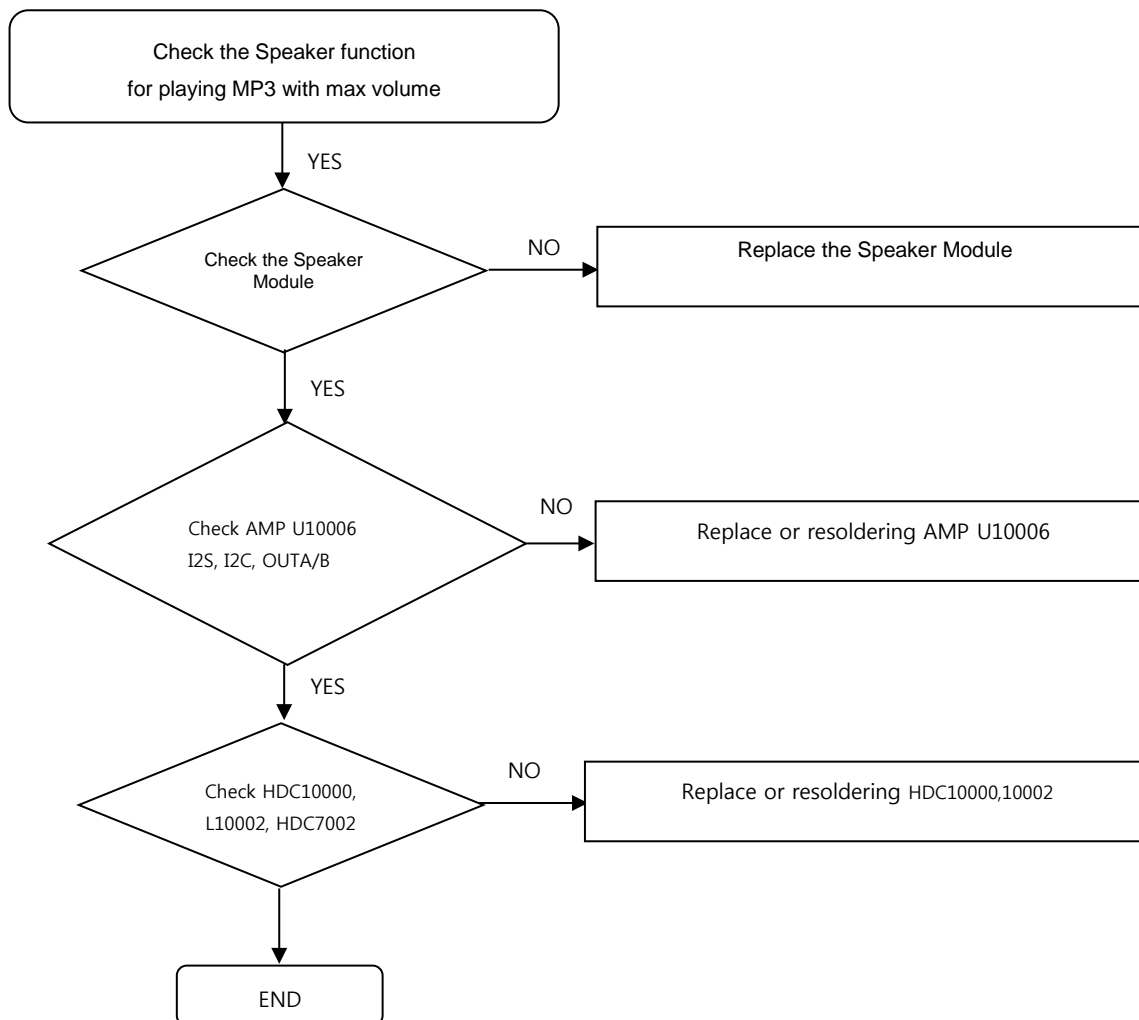

8. Level 3 Repair

8-4-23. Earjack Part - Rx

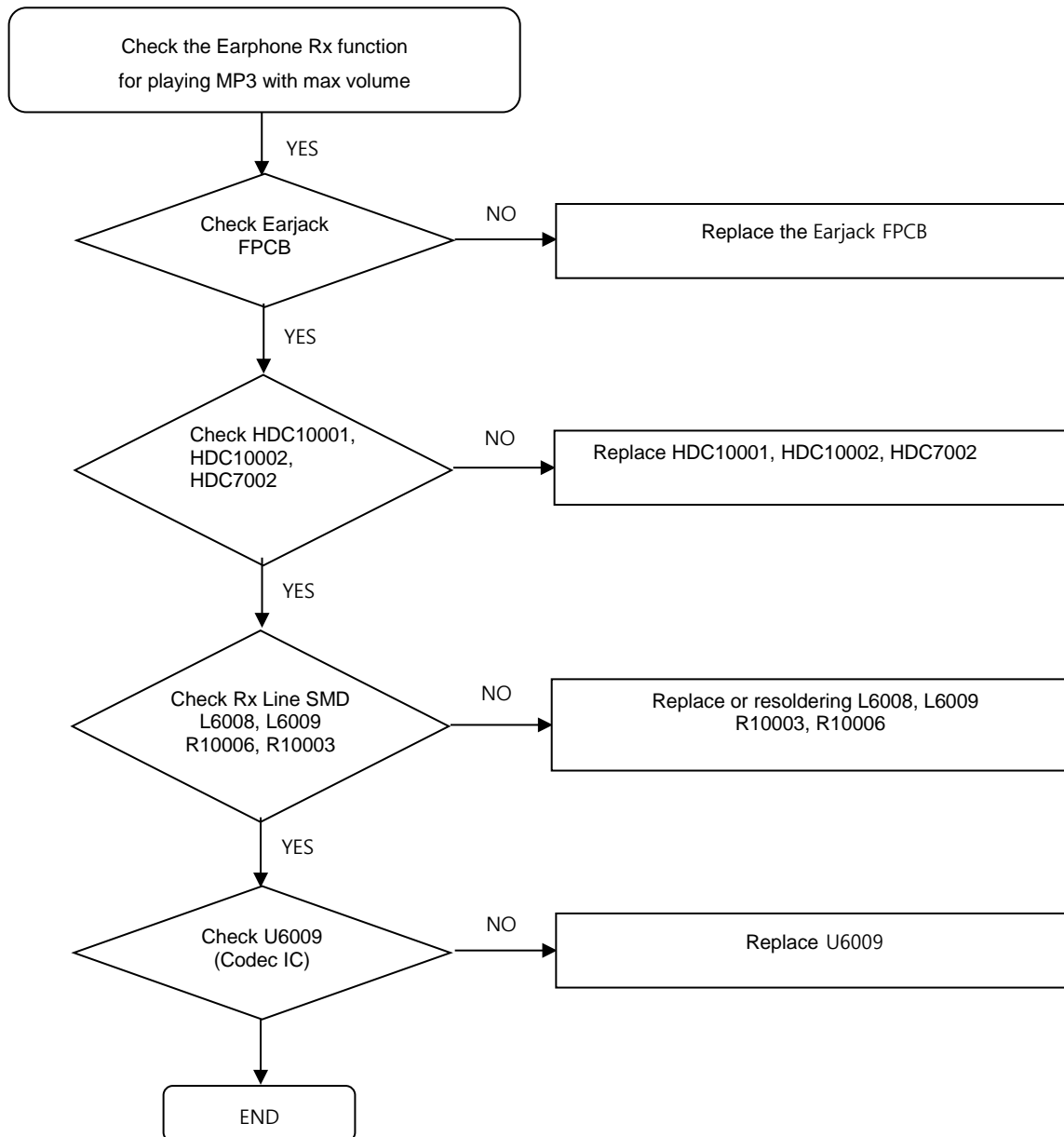

8. Level 3 Repair

8-4-24. Earjack Part - Tx

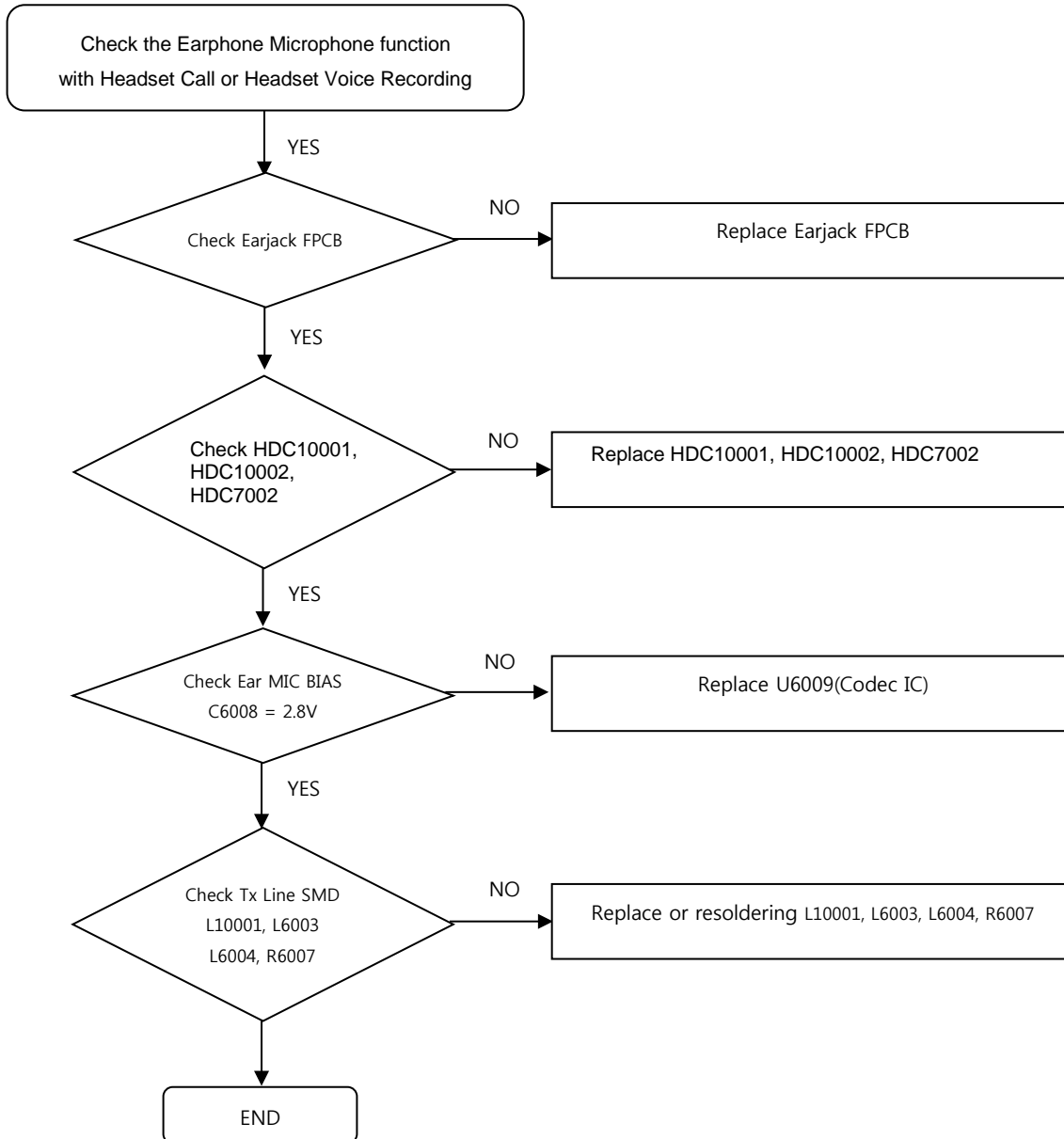

8. Level 3 Repair

8-4-25. BT/WIFI

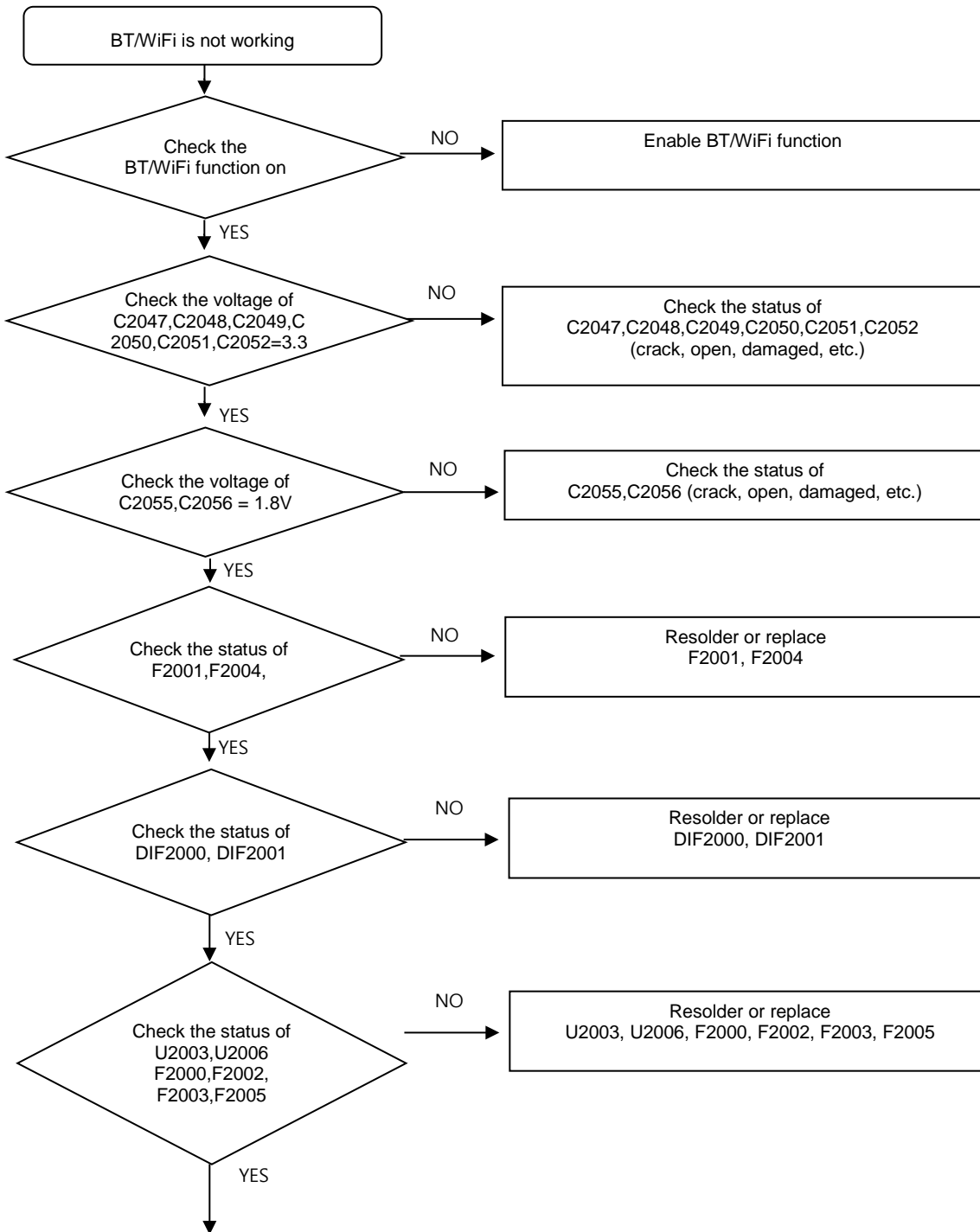

8. Level 3 Repair

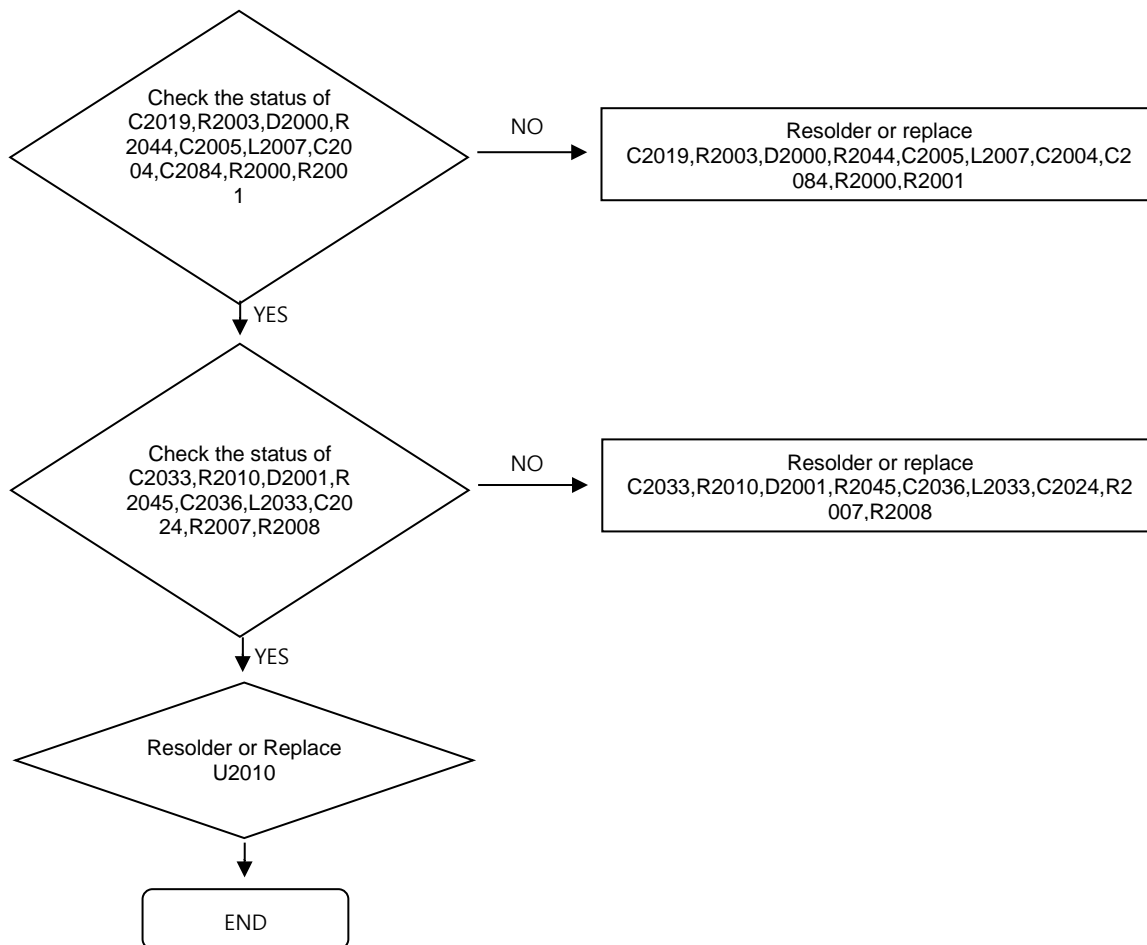

8. Level 3 Repair

8-4-26. GPS

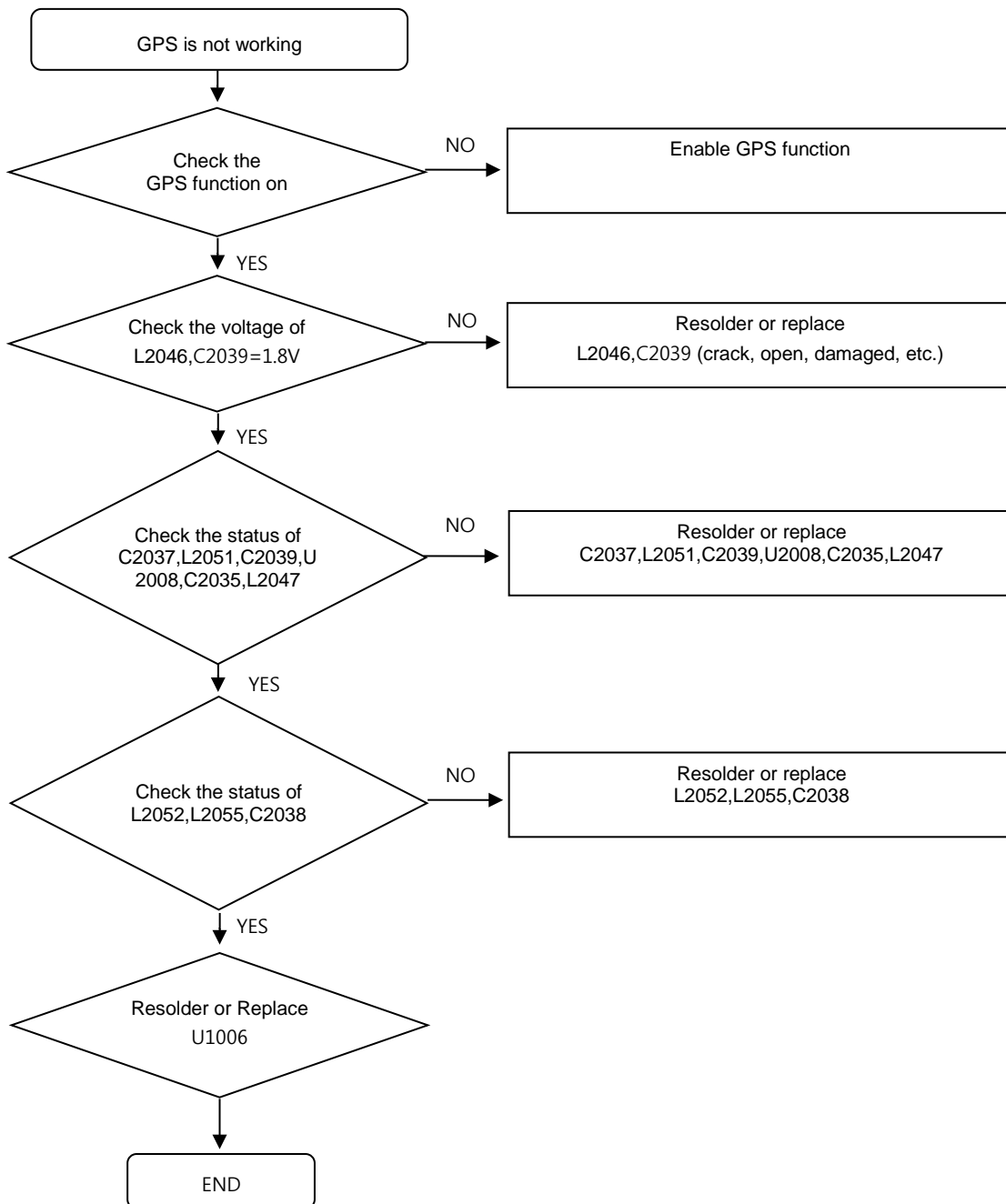

8. Level 3 Repair

8-4-27. RX (GSM1800,1900 / WCDMA 1,2,4/ LTE 1,2,3,4,66) [SM-T835]

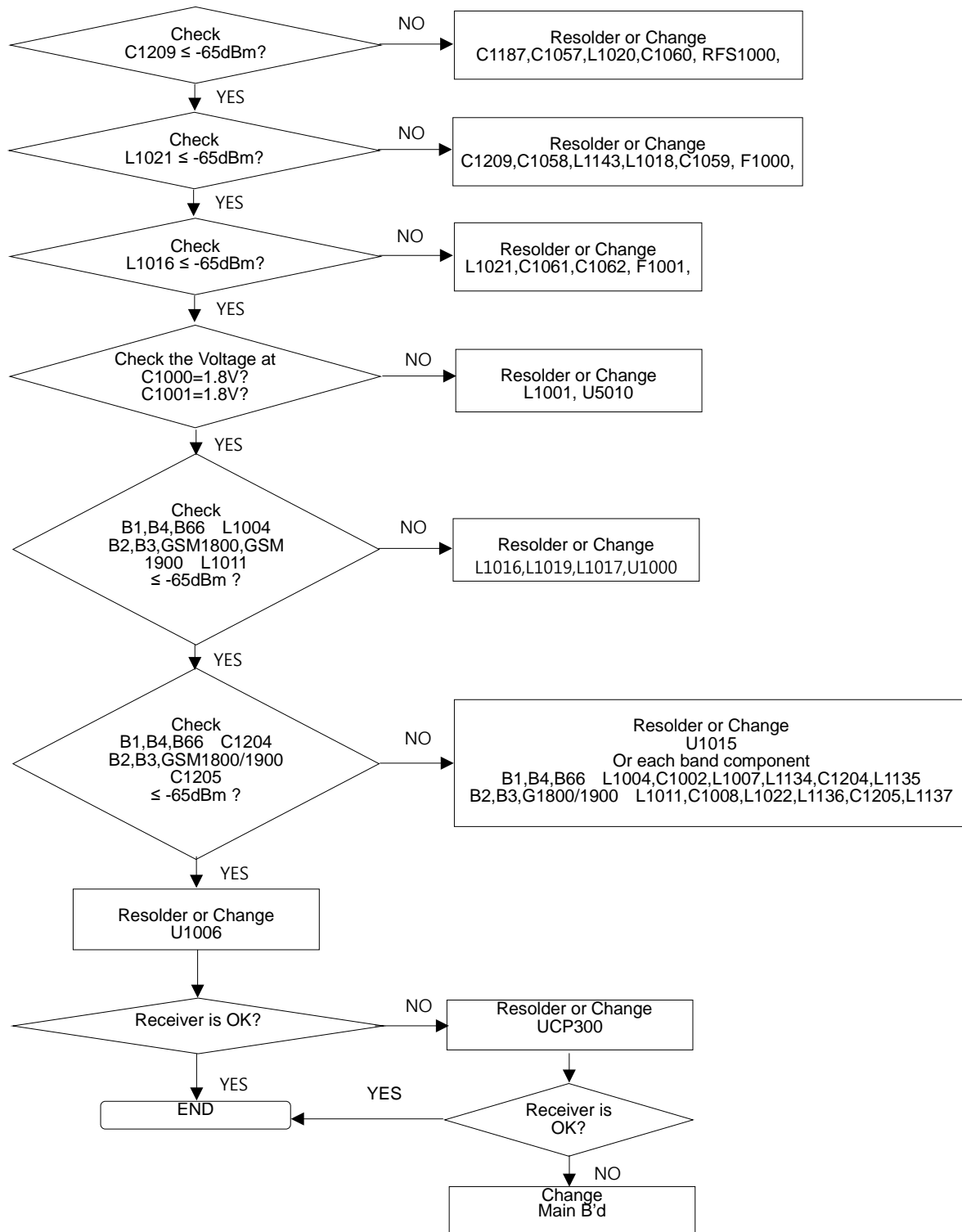

8. Level 3 Repair

8-4-28. RX (GSM850,900 / WCDMA 5,8/ LTE 5,8,12,13,17,20,28) [SM-T835]

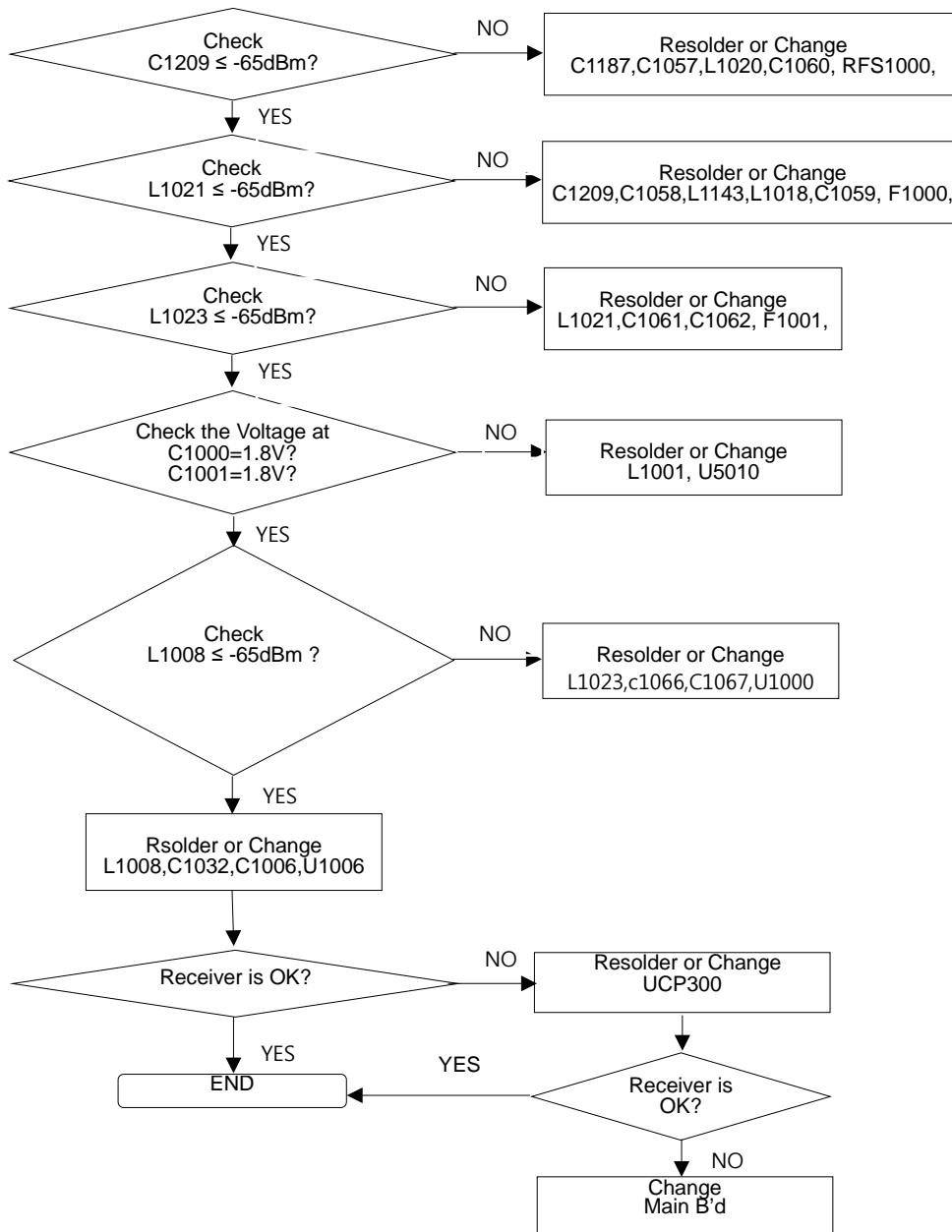

8. Level 3 Repair

8-4-29. RX (LTE 7,38,40,41) [SM-T835]

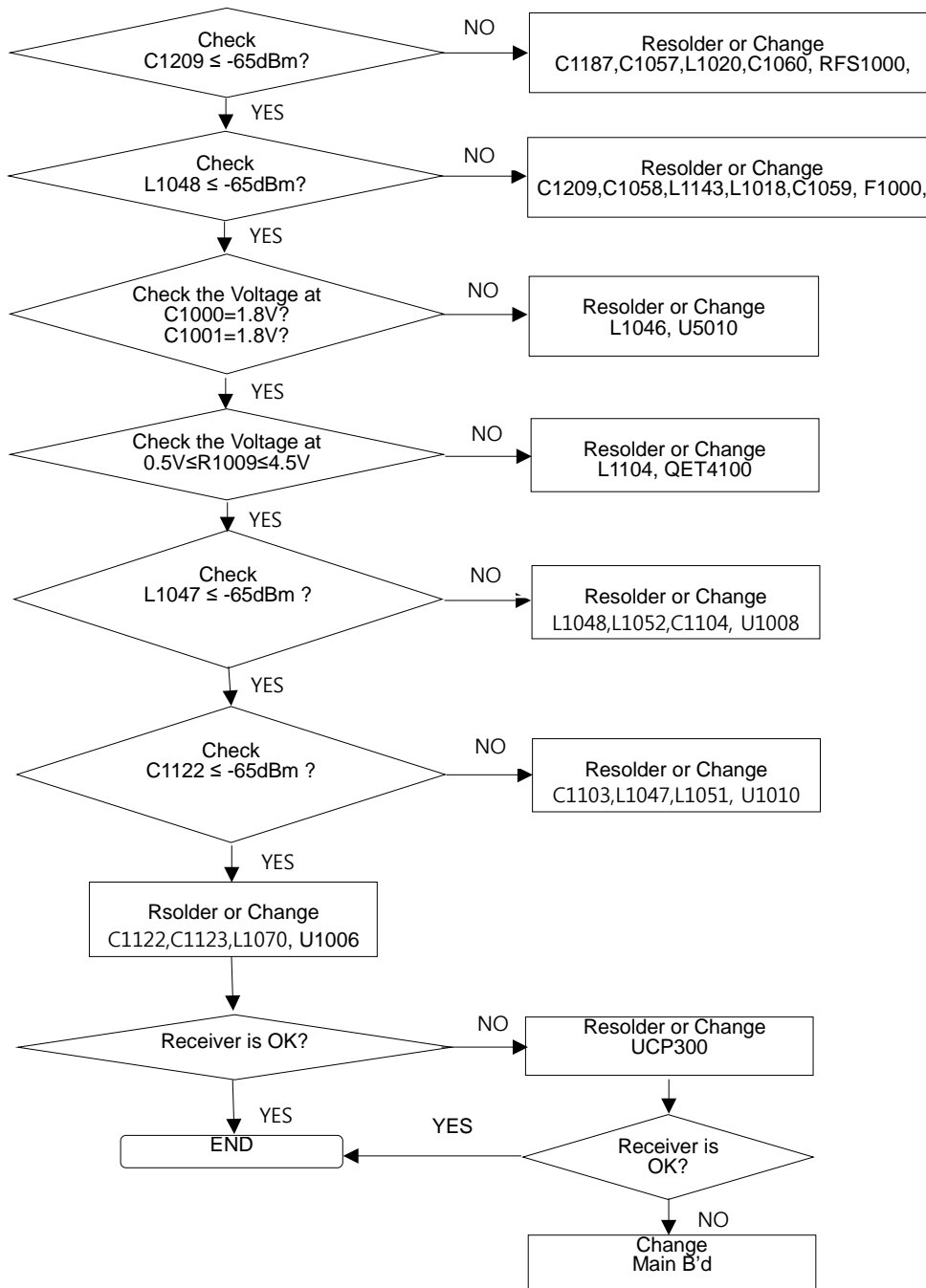

8. Level 3 Repair

8-4-30. TX (GSM1800,1900 / WCDMA 1,2,4/ LTE 1,2,3,4,66) [SM-T835]

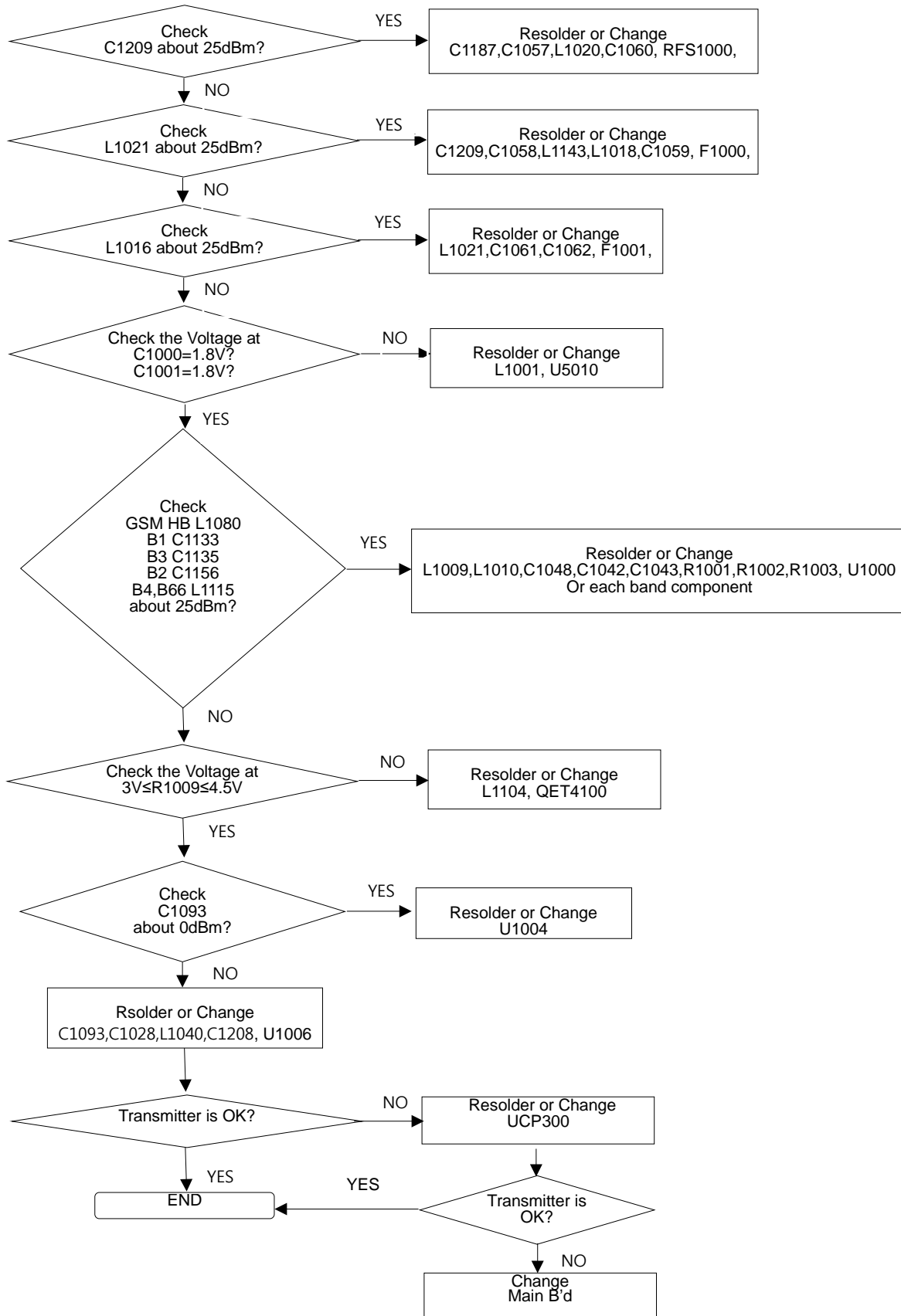

8. Level 3 Repair

8-4-31. TX (GSM850,900 / WCDMA 5,8/ LTE 5,8,12,13,17,20,28) [SM-T835]

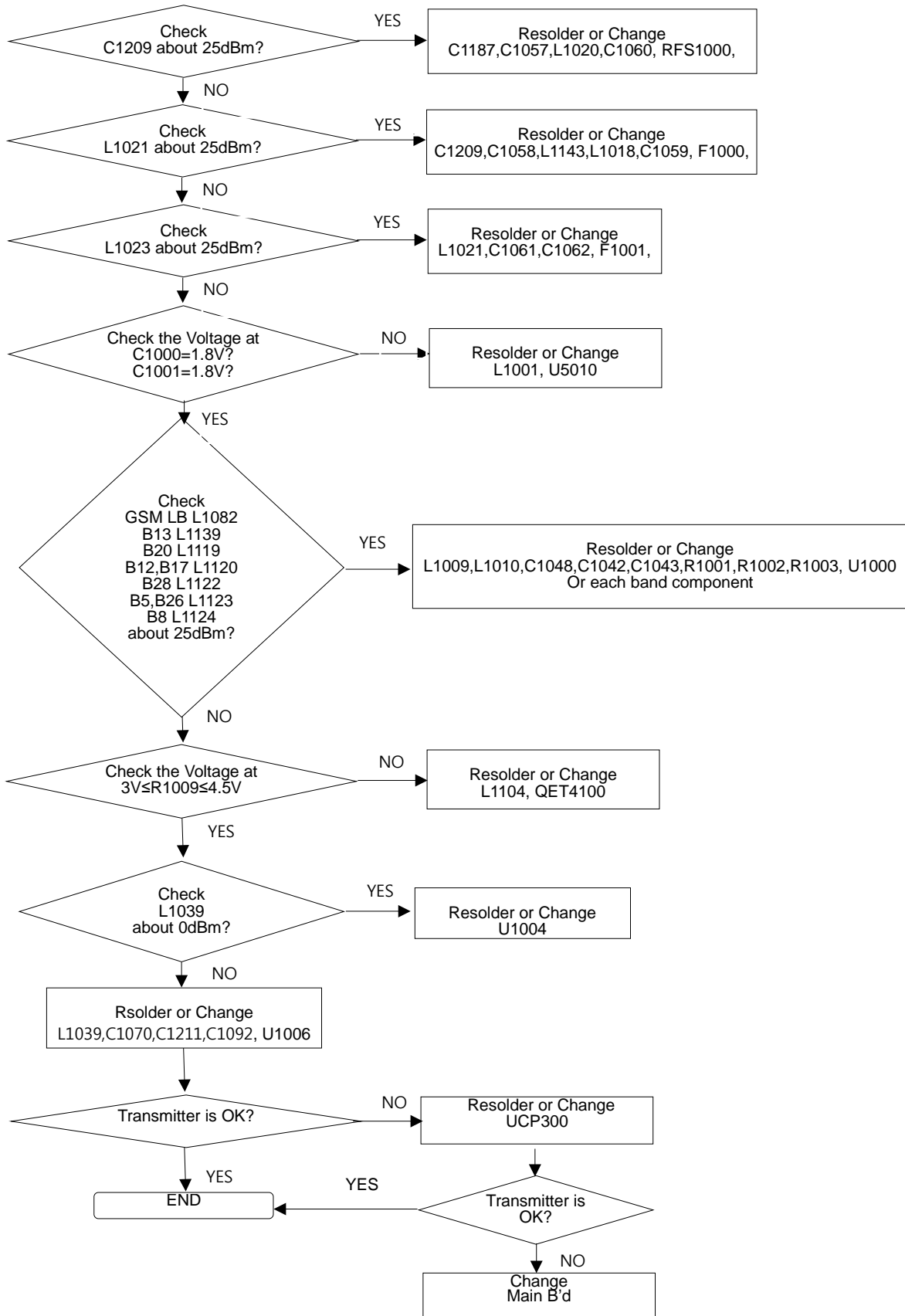

8. Level 3 Repair

8-4-32. TX (LTE 7,38,40,41) [SM-T835]

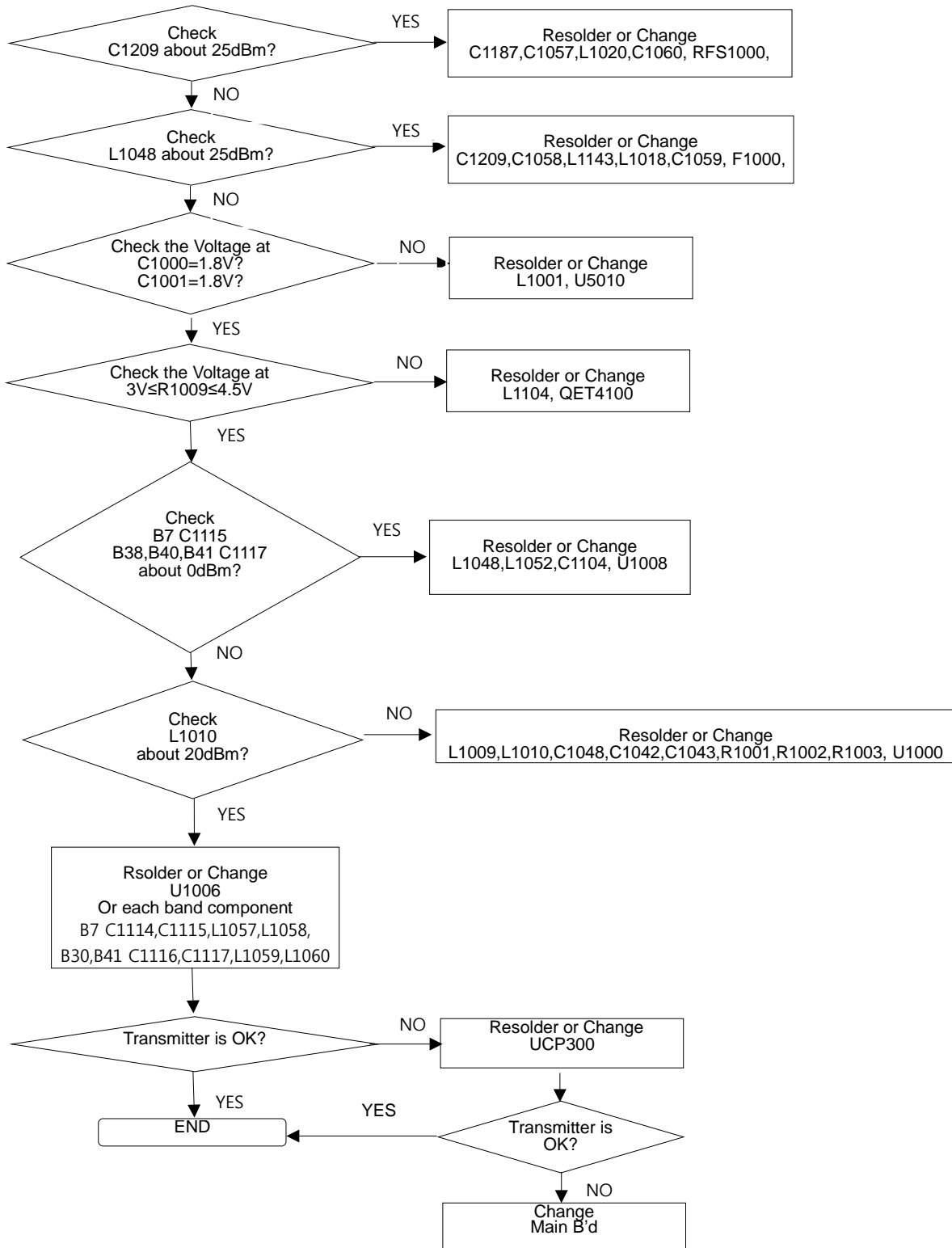

9. Reference Abbreviation

Reference Abbreviation

- **AAC**: Advanced Audio Coding.
- **AVC** : Advanced Video Coding.
- **BER** : Bit Error Rate
- **BPSK**: Binary Phase Shift Keying
- **CA** : Conditional Access
- **CDM** : Code Division Multiplexing
- **C/I** : Carrier to Interference
- **DMB** : Digital Multimedia Broadcasting
- **EN** : European Standard
- **ES** : Elementary Stream
- **ETSI**: European Telecommunications Standards Institute
- **MPEG**: Moving Picture Experts Group
- **PN** : Pseudo-random Noise
- **PS** : Pilot Symbol
- **QPSK**: Quadrature Phase Shift Keying
- **RS** : Reed-Solomon
- **SI** : Service Information
- **TDM** : Time Division Multiplexing
- **TS** : Transport Stream

SAMSUNG